

# Part 2

# Assembly

Instructions

## Climb Module

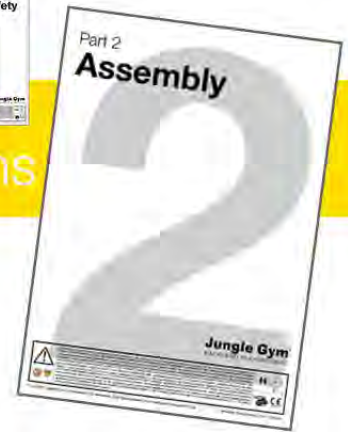

### 1-Climb Module 200

857\_105

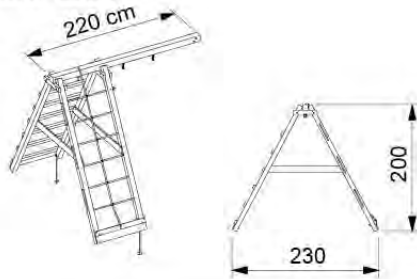

### 2-Climb Module 200

857\_106

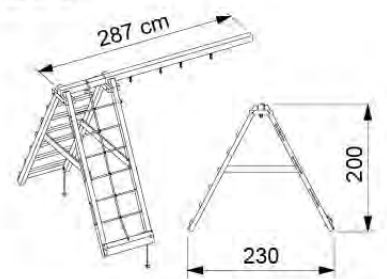

### 1-Climb Module 220

857\_157

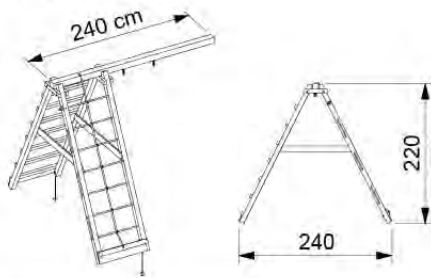

### 2-Climb Module 220

857\_158

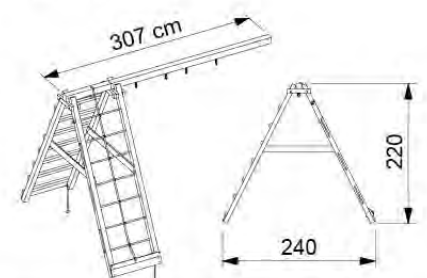

### 1-Climb Module 220 Extra

850\_231

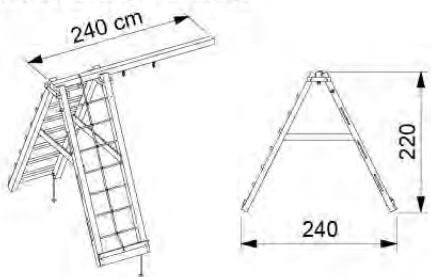

### 2-Climb Module 220 Extra

850\_232

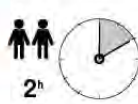
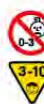
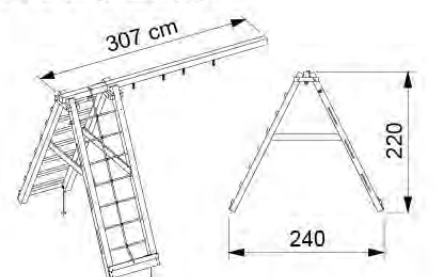

# Jungle Gym









BACKYARD PLAYGROUNDS

since 1988

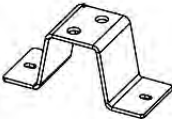
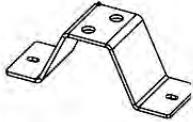
	1 position	2 positions		1 position	2 positions
EN. Warnings. Only for domestic use. Maximum number of users is:	3	4	LT. Įspėjimai. Tik butiniam naudojimui. Maksimalus naudotojų skaičius :	3	4
DE. Achtung. Nur für den Hausgebrauch. Maximale Benutzerzahl:	3	4	HR. Upozorenja. Samo za kućansku uporabu. Maksimalan broj korisnika je :	3	4
FR. Attention. Réservé à un usage familial. Le nombre maximal d'utilisateurs est de :	3	4	HU. Figyelmeztetések. Csak otthoni használatra! A használók max. száma :	3	4
NL. Waarschuwingen. Uitsluitend voor huishoudelijk gebruik. Het maximale aantal gebruikers is :	3	4	NO. Advarsler. Kun for privat bruk. Maksimalt antal brukere er :	3	4
BG. Внимание. За употреба само в домашни условия. Максималният брой потребители е :	3	4	PL. Ostrzeżenia. Wyłącznie do użytku domowego. Maksymalna liczba użytkowników to :	3	4
ES. Advertencias. Sólo para uso doméstico. Número máximo de usuarios :	3	4	PT. Avisos. Apenas para uso doméstico. O número máximo de utilizadores é :	3	4
CS. Varování. Jen pro domácí použití. Maximální počet uživatelů je :	3	4	RO. Avertismente. Numai pentru uz domestic. Numărul maxim de utilizatori este :	3	4
DA. Advarsler. Kun til privat brug. Maksimalt antal brugere er :	3	4	RU. Предостережения. Только для домашнего использования.	3	4
ET. Hoiatused. Ainult koduseks kasutamiseks. Maksimaalne kasutajate arv on :	3	4	Максимальное количество пользователей - :	3	4
EL. Προειδοποιήσεις. Μόνο για οικιακή χρήση. Μέγιστος αριθμός χρηστών :	3	4	SK. Upozornenia. Iba na domáce použitie. Maximálne množstvo osôb je :	3	4
IS. Varnaðarorð. Engöngu fyrir einkanoðkun í heimahúsum og á einkaöðum. Hámarksfjöldi notenda er :	3	4	SL. Opozorila. Samo za domačo uporabo. Maksimalno število uporabnikov je :	3	4
IT. Avvertenze. Solo per uso domestico. Massimo numero di utenti è :	3	4	FI. Varoitukset. Ainoastaan kotikäyttöön. Käyttäjää yhteensä enintään :	3	4
LV. Brīdinājumi. Izmantot tikai mājās. Maksimālais lietotāju skaits ir :	3	4	SR. Upozorenja. Samo za kućnu uporabu. Maksimalan broj korisnika je :	3	4
			SV. Varningar. Endast för hemmabruk. Det maximala antalet användare är :	3	4
			TR. Uyarılar. Sadece ev kullanımı için. Maksimal kullanıcı sayısı :		

# 01 What's in the Delivery?



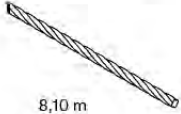



457\_106

<p>1x 040_805 General Safety</p> <p>1x 040_925 Click Start Guide</p> 	<p>7x 022_455</p> 	<p>2x 005_528</p>  <p><b>Module</b></p>	<p>2x 005_529</p>  <p><b>Module Extra</b></p>	<p>1x 020_317</p>  <p>3,40 m</p>
<p>2x 007_001</p> 	<p>4x 101_003</p> 	<p>1x 008_010 ø7 mm</p> <p>1x 104_403 ø7,5 mm</p> 	<p>1x 100_161</p> 	<p>1x 020_318</p>  <p>8,10 m</p>

# 02 Hardware

100\_161 HWP Climb module

20221004

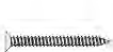
001_422	<b>6x</b>		ø8 x 137mm	023_031	<b>4x</b>		ø5mm
001_417	<b>8x</b>		ø8 x 80mm				
001_406	<b>4x</b>		ø8 x 45mm				
002_223	<b>45x</b>		ø5 x 80mm				
002_220	<b>43x</b>		ø5 x 45mm				
002_301	<b>7x</b>		ø3,9 x 40mm				

# 03 Timber

		L		1-Climb Module 200	2-Climb Module 200	1-Climb Module 220	2-Climb Module 220	1-Climb Module 220 Extra	2-Climb Module 220 Extra
		657_105	657_106	657_155	657_156	650_231	650_232		
A	A240	239cm - 240cm	4 x	4 x	4 x	4 x			
	A220	219cm - 220cm							
B	B240	239cm - 240cm	1 x	1 x	1 x	1 x	5 x	5 x	
	B220	219cm - 220cm		1 x		1 x			1 x
	B67	66cm - 67cm							
C	C74	73cm - 74cm	7 x	7 x	8 x	8 x	8 x	8 x	
	C37	36cm - 37cm	4 x	5 x	4 x	5 x	4 x	5 x	
D	D141	140cm - 141cm	3 x	3 x	3 x	3 x	3 x	3 x	
	D74	73cm - 74cm	2 x	2 x	2 x	2 x	2 x	2 x	

26-Oct-2021

# 04 Product ID

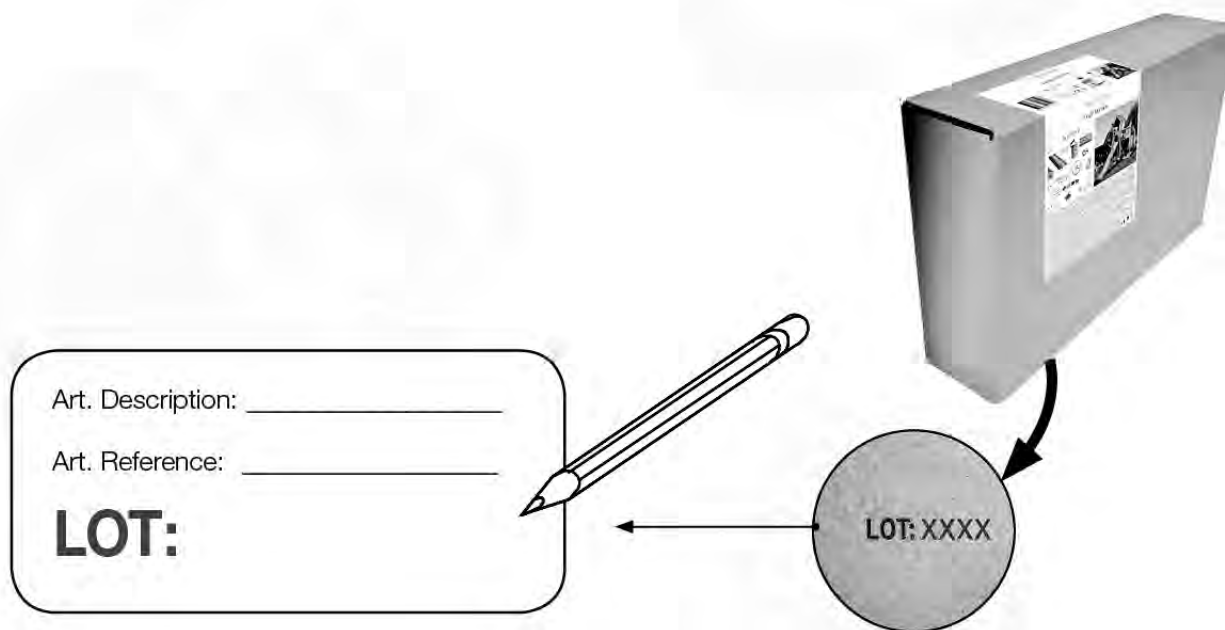

# 05 Safe Playground Planning

05-1

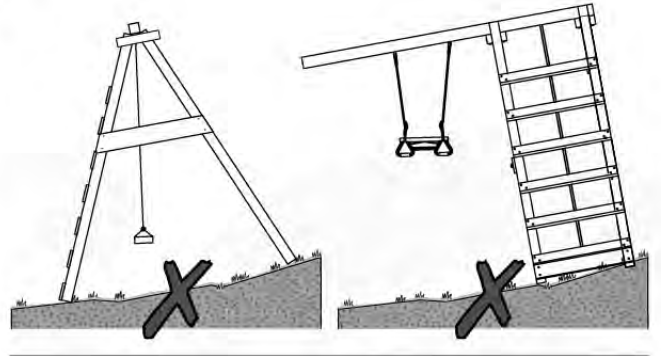
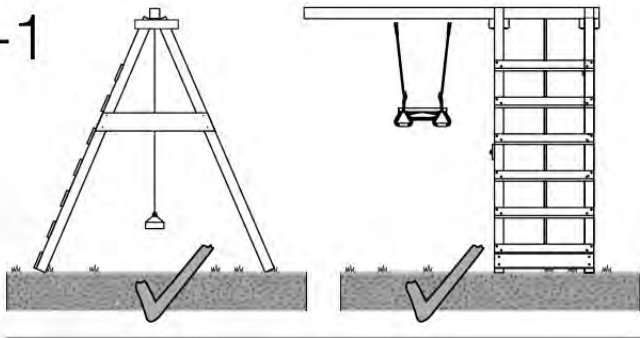

05-2

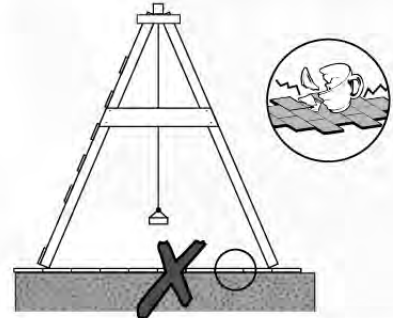
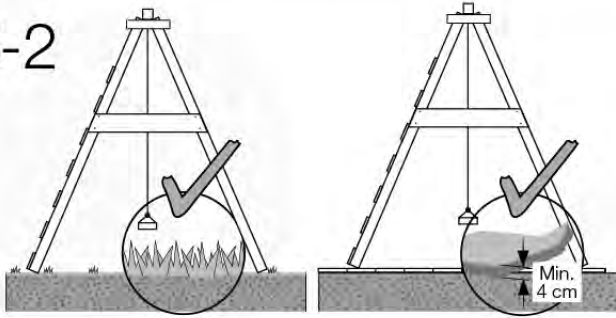

05-3

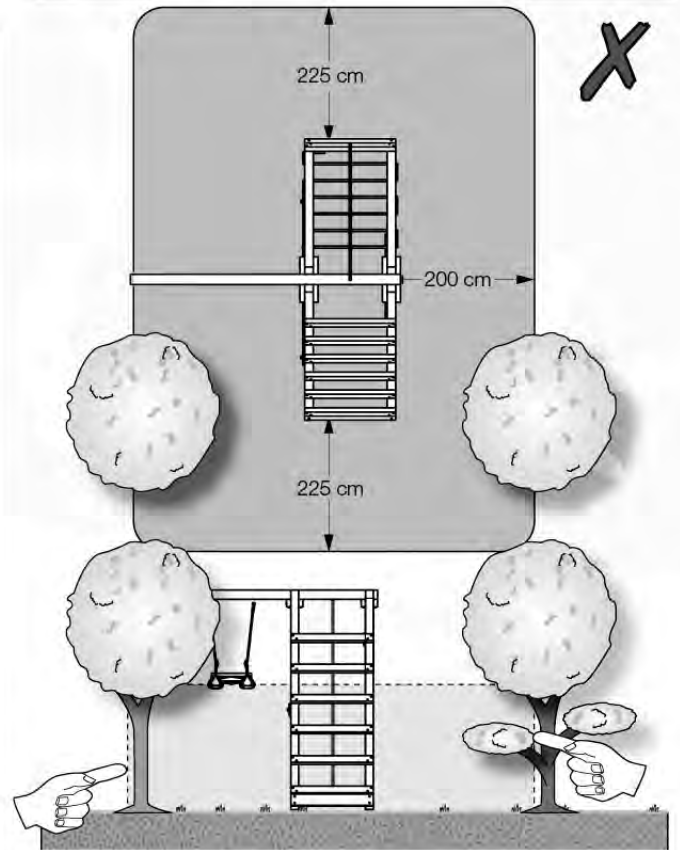
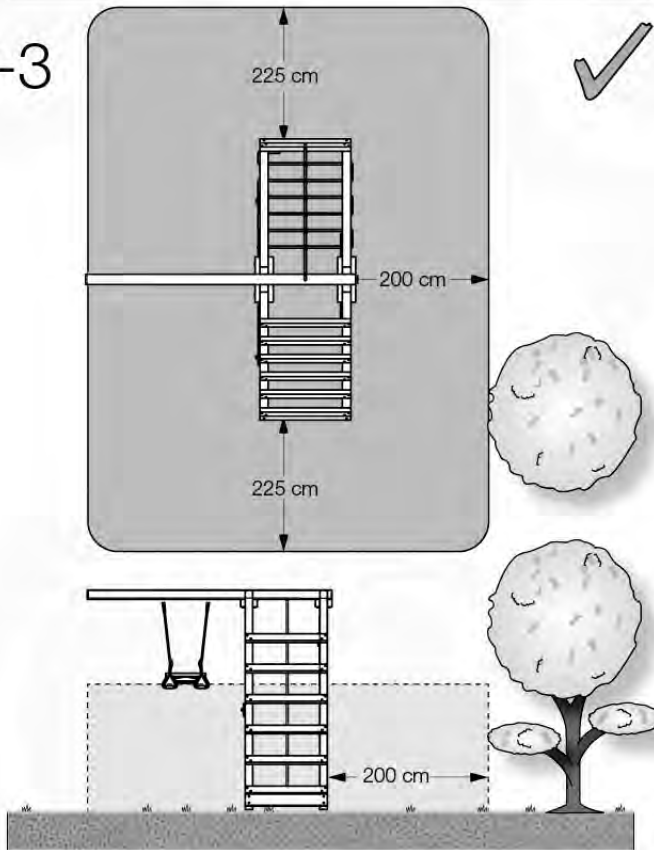

05-4

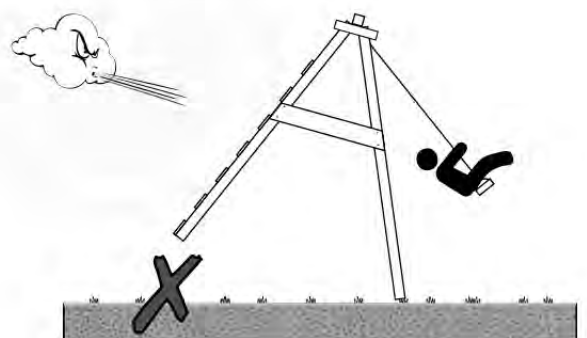
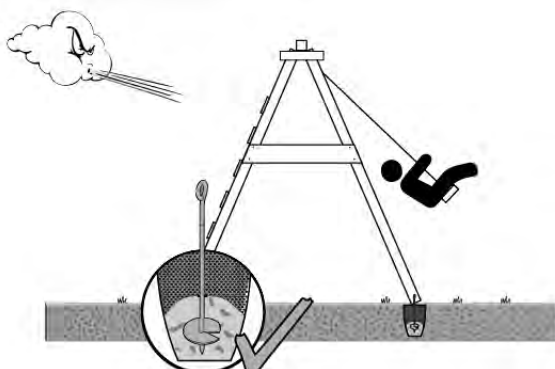

# 05-5

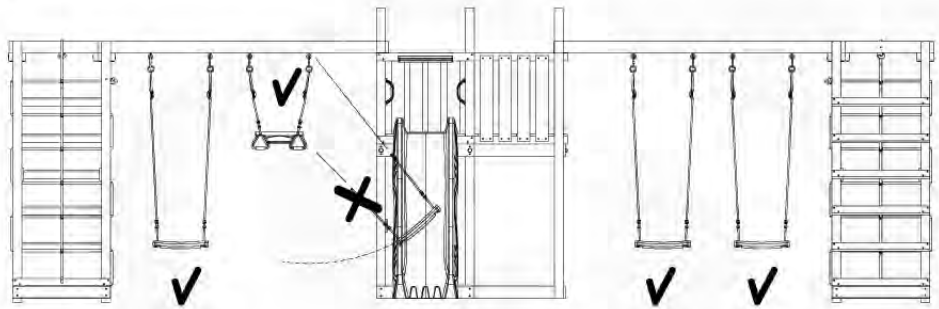
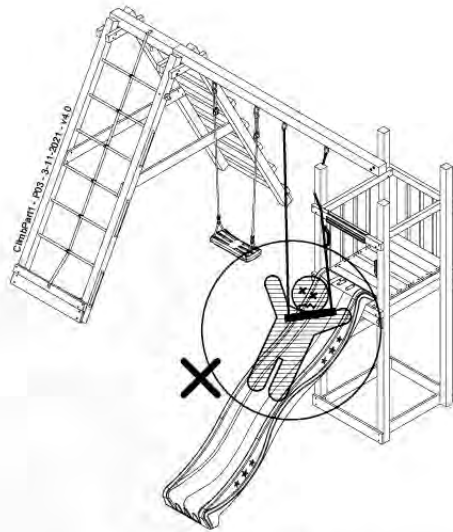

# 05-6

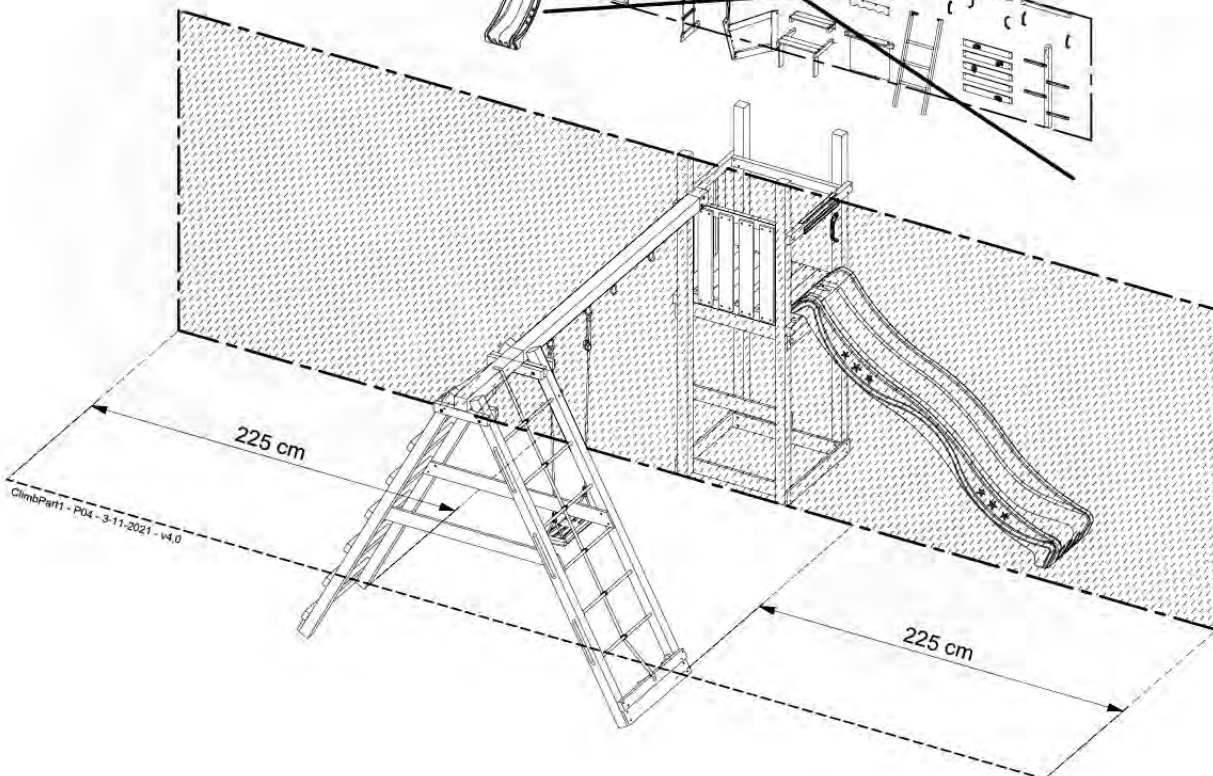
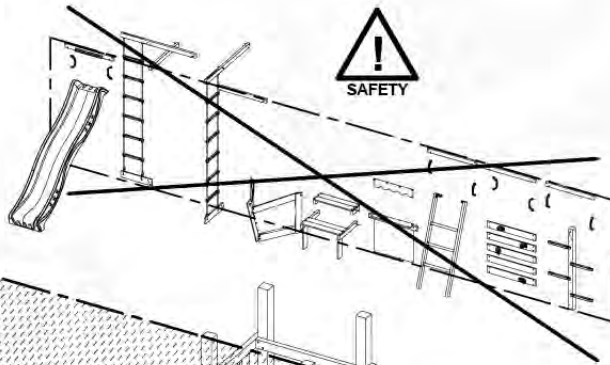

# 06

	PartNo	PartName	QTY.
Hardware Pack	001_406	Stealth Screw 8x45	2
	001_417	Stealth Screw 8x80	8
	001_422	Stealth Screw 8x137	6
	002_220	Gap Point Screw T25 - 5x45	43
	002_223	Gap Point Screw T25 - 5x80	45
	002_301	Dry Wall Screw PH2 3.9 x 40 mm	7
Other	005_528	Swing Beam Bracket 7x7	2
	005_529	Swing Beam Bracket 9x9	2
	007_001	Ground-anchor	2
	020_317	Rope Polyester 16mm Green 3.4m	1
	020_318	Rope Polyester 16mm Green 8.1m	1
	022_455	Rope Cross Connector Egg	7
	023_031	Finishing Washer GPS 5.0	4
	101_003	Swing hook with Carabiner	4

ClimbPart1 - Page 3-11-2021 - M 0

## 06-1

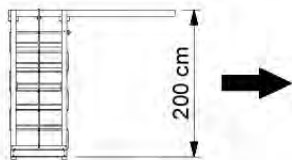

1-Climb Module 200  
2-Climb Module 200

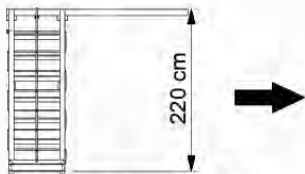
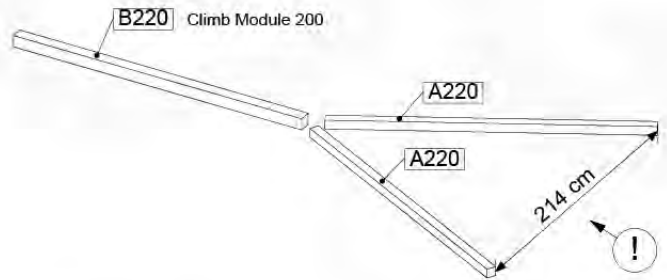

1-Climb Module 220  
2-Climb Module 220

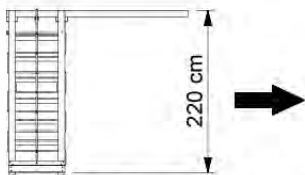
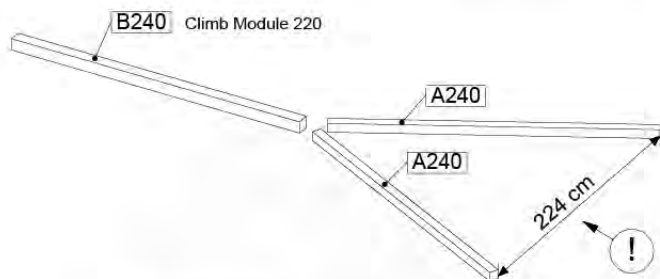

1-Climb Module 220 Extra  
2-Climb Module 220 Extra

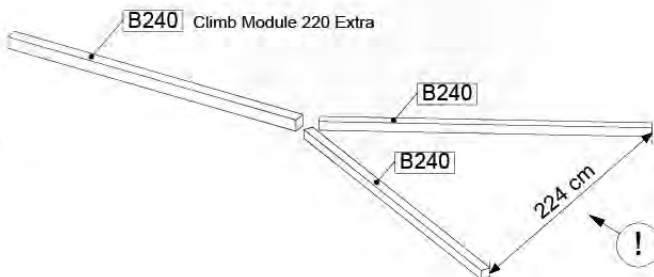

ClimbPart1 - P05ALL - 3-11-2021 - M 0



# 06-4

Climb Module 200

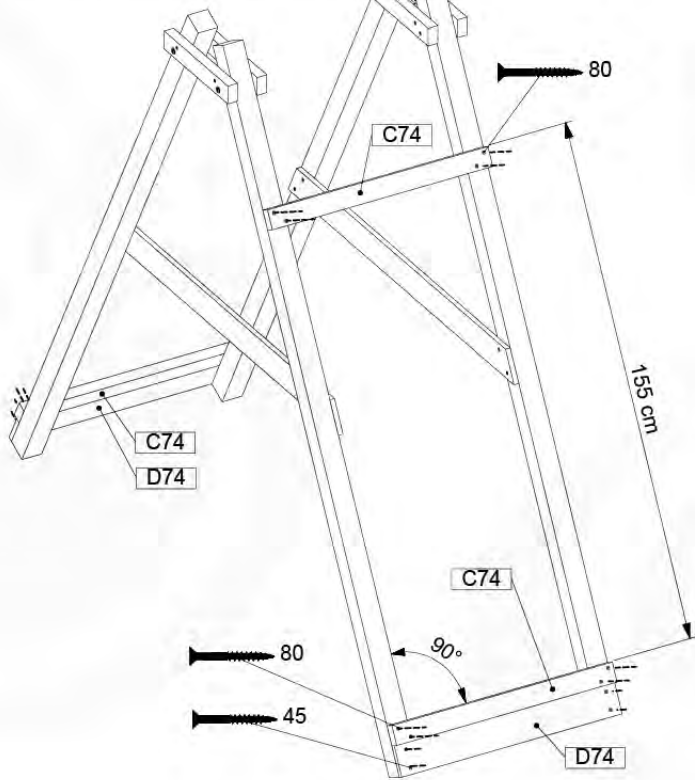

Climb Module 220 / 220 Extra

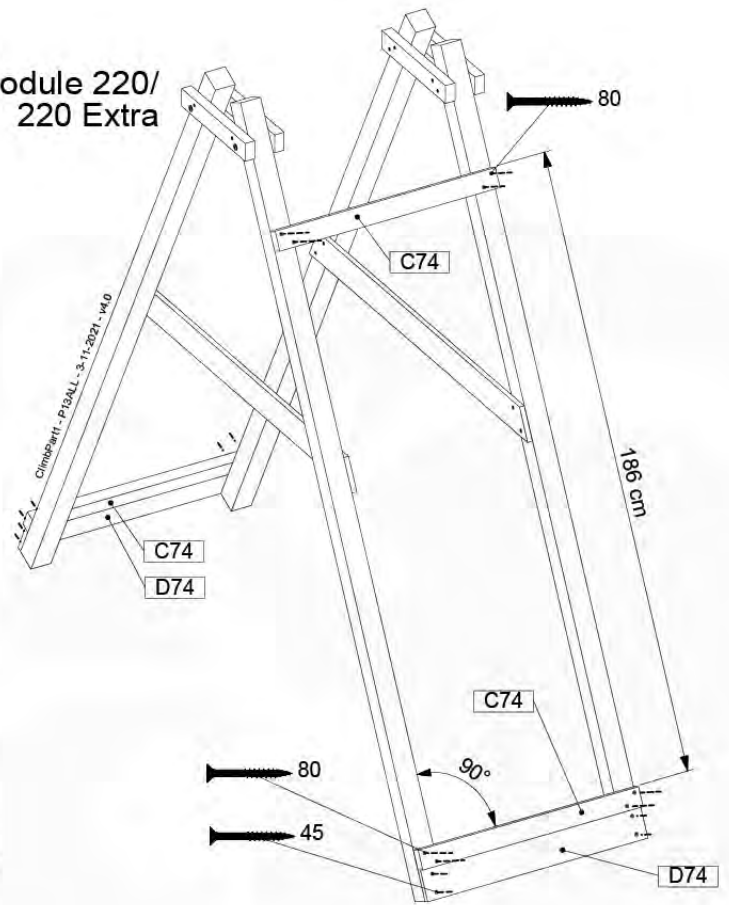

# 06-5

Climb Module 200

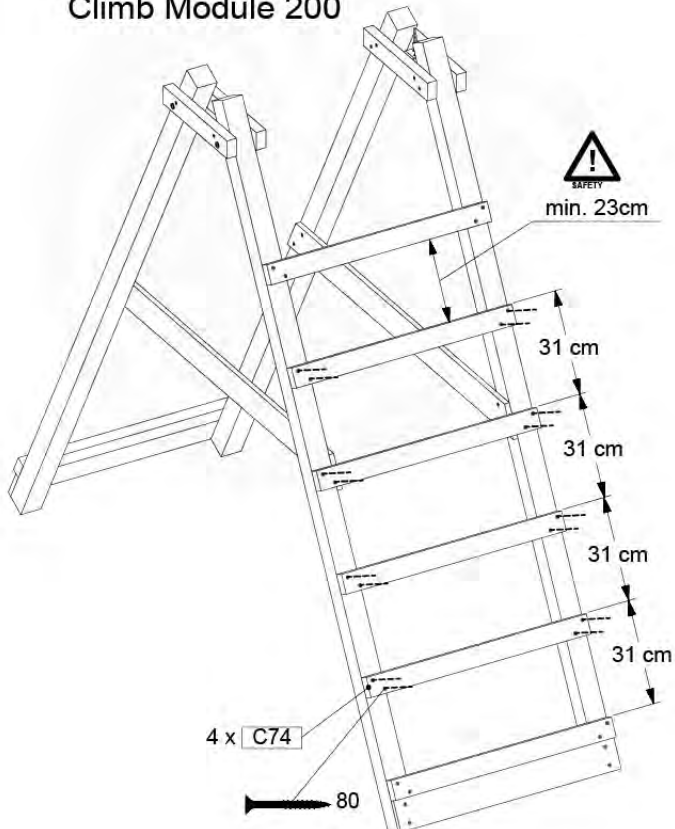

Climb Module 220 / 220 Extra

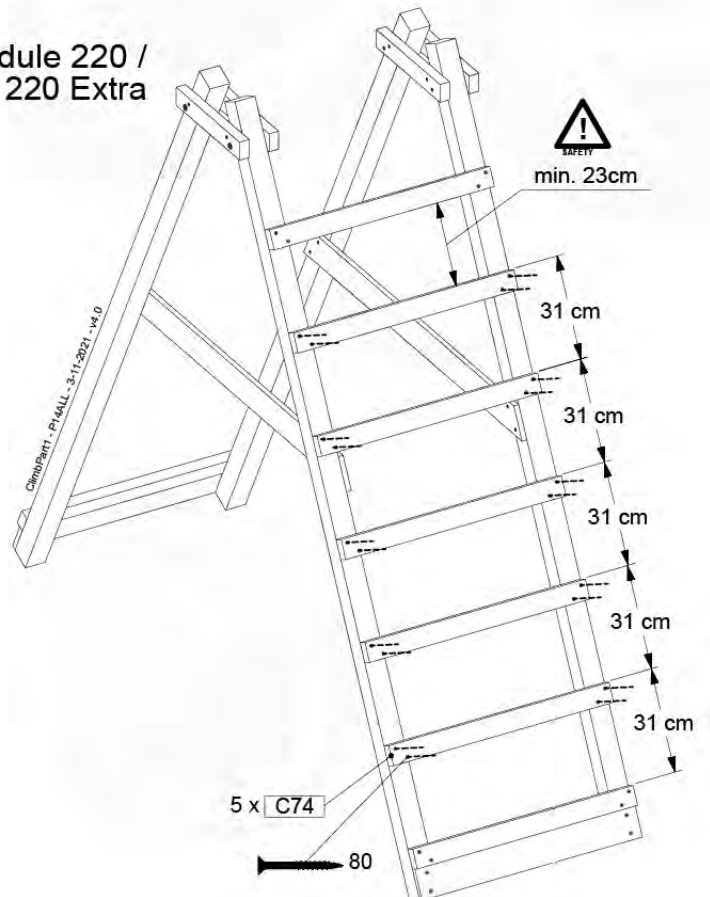



# 06-6

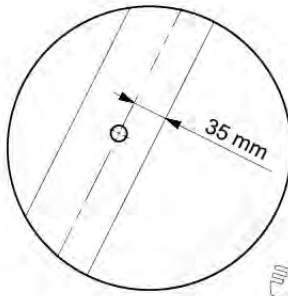

## Climb Module 220 / 220 Extra

### Climb Module 200

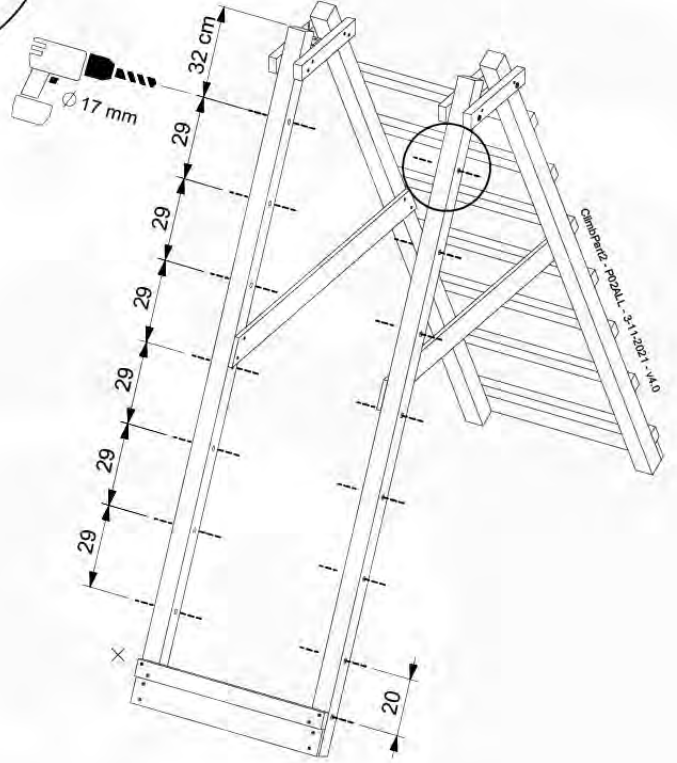
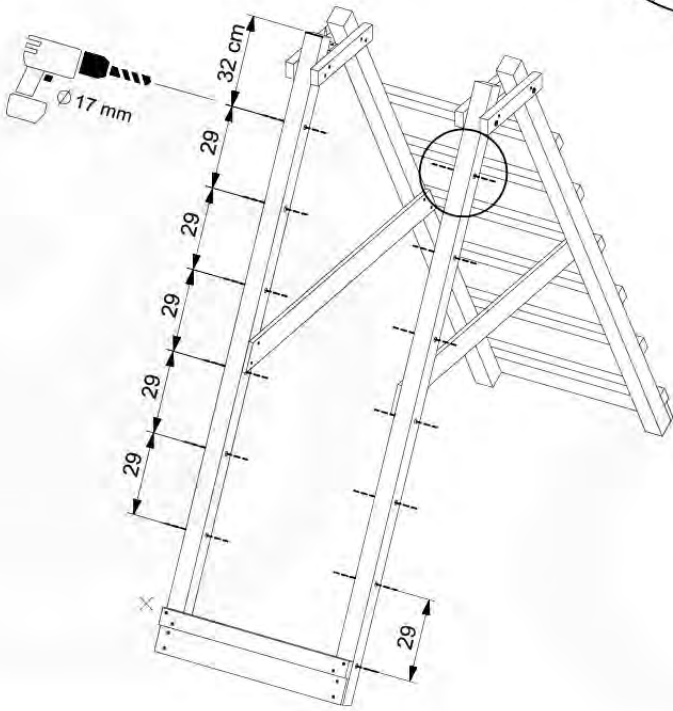

# 06-7

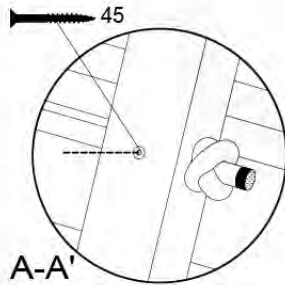

## Climb Module 220 / 220 Extra

### Climb Module 200

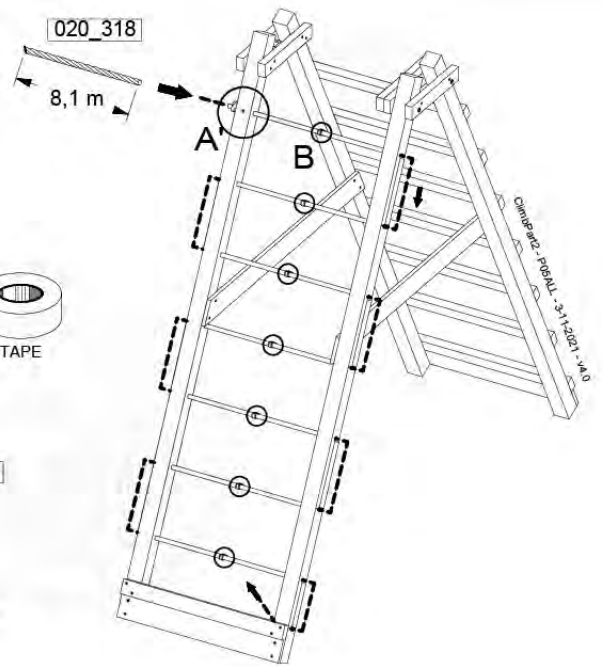
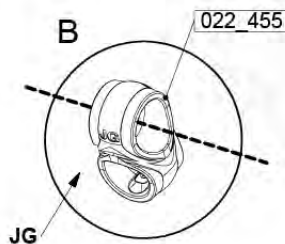
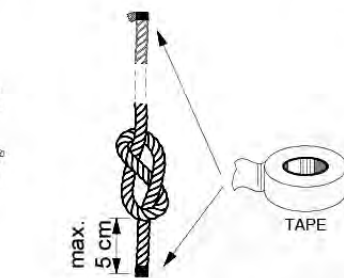
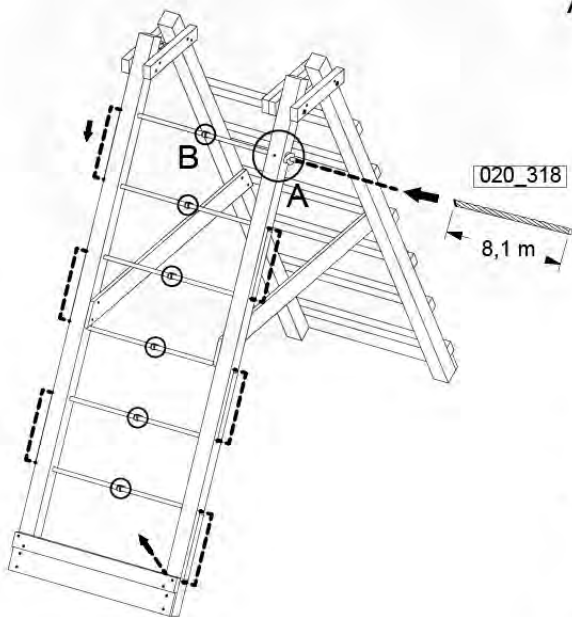

6-7x

### Climb Module 200

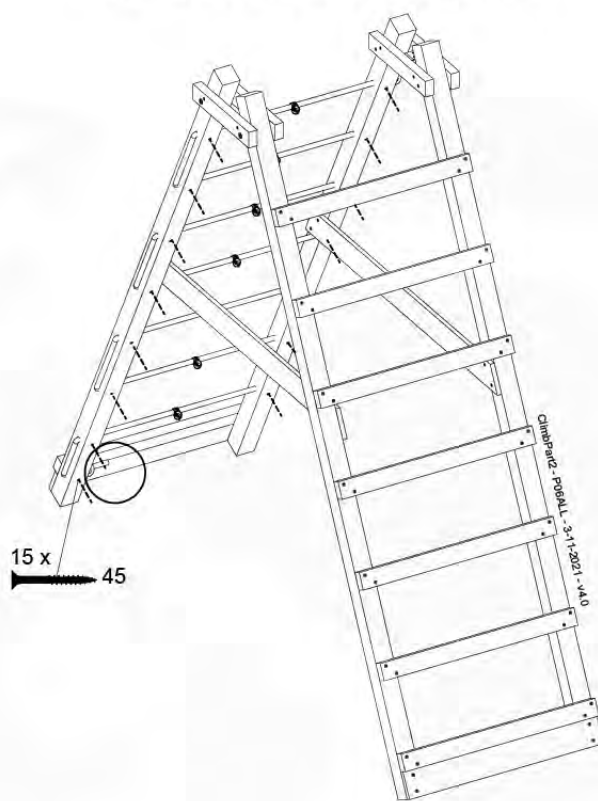
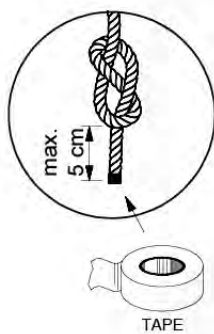
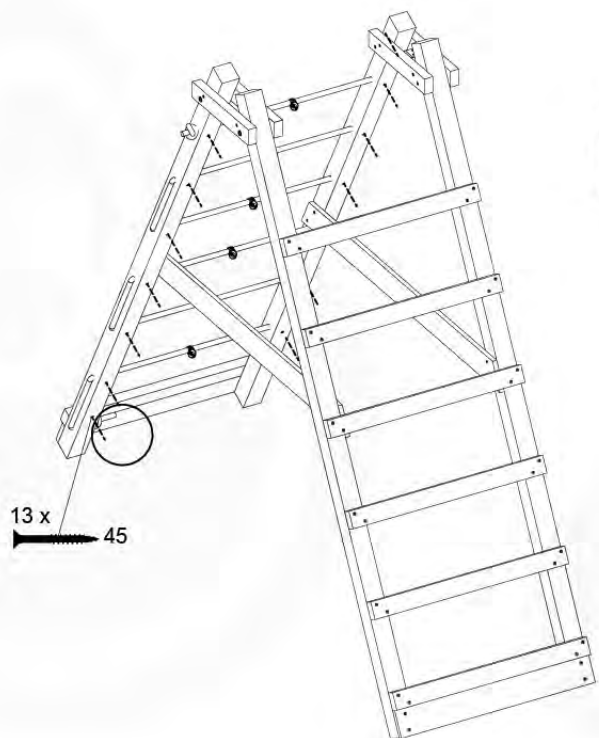

# 06-9

B240  
B220



1 position

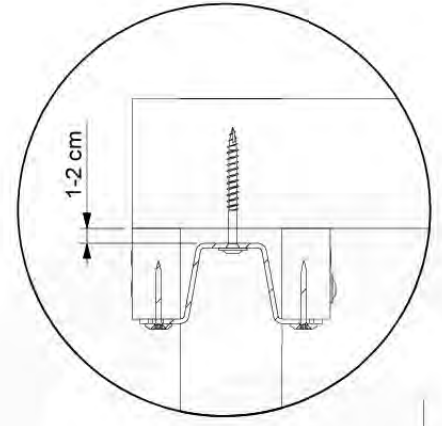

B240  
B220

ClimbPart2 - P09-1P - 3-11-2021 - v4.0

2 x 80



2 x 80

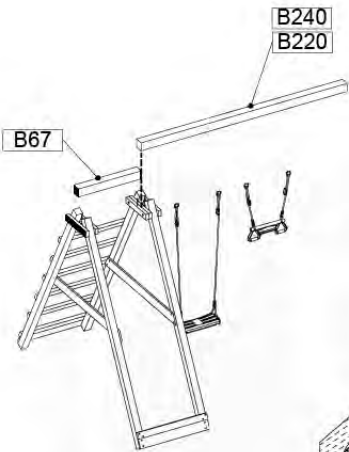

2 positions

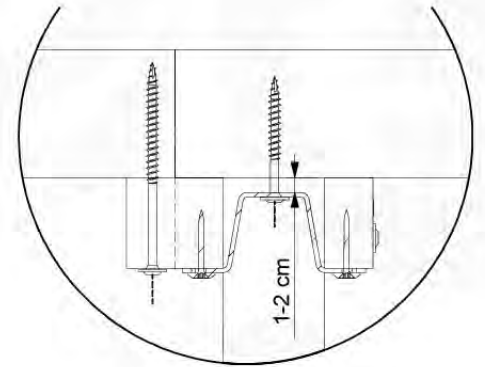

B240  
B220

B67

ClimbPart2 - P10-2P - 3-11-2021 - v4.0

2 x 137

2 x 80



C37

2 x 80

B240  
B220



# 06-10

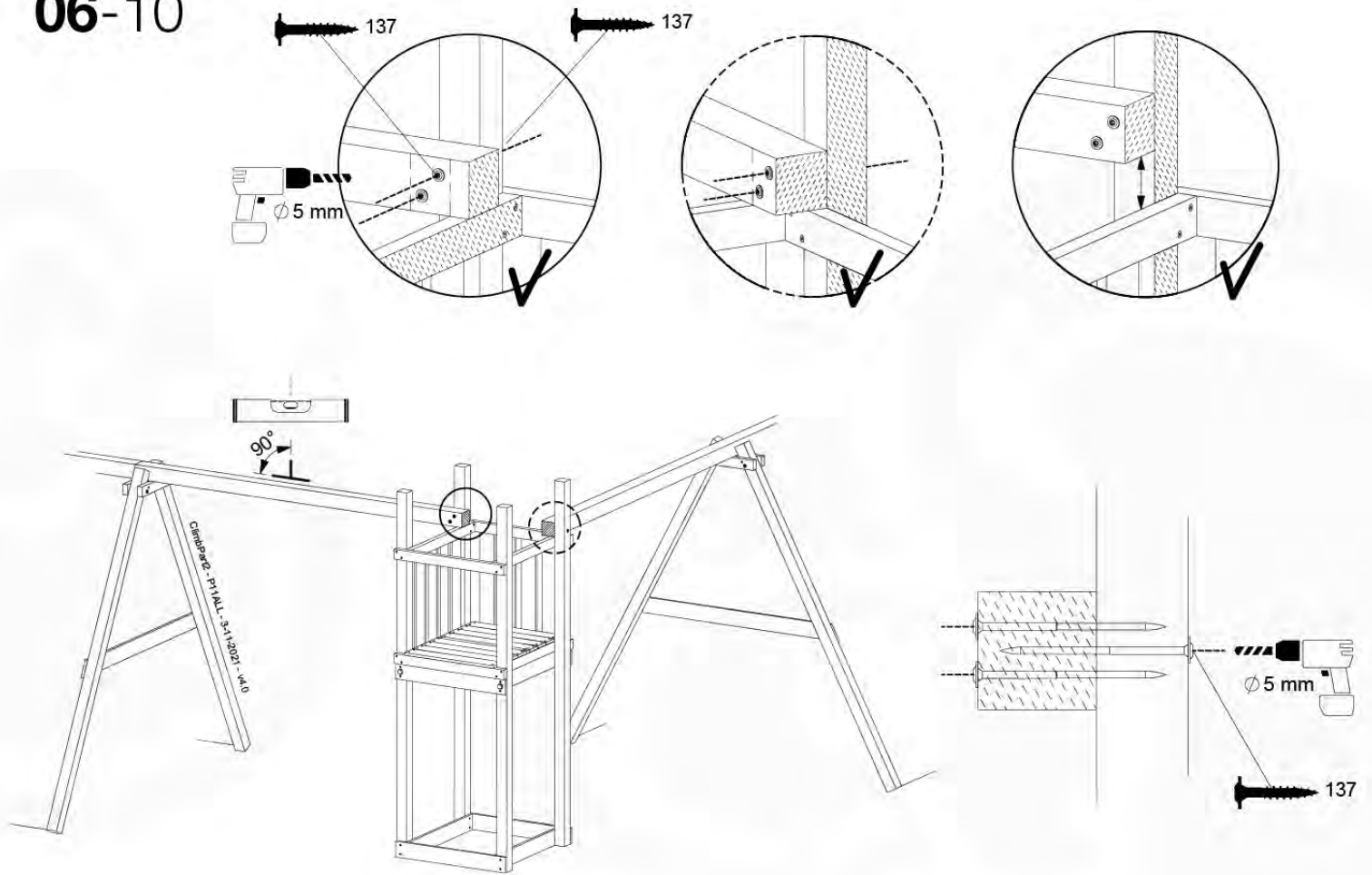

# 06-11

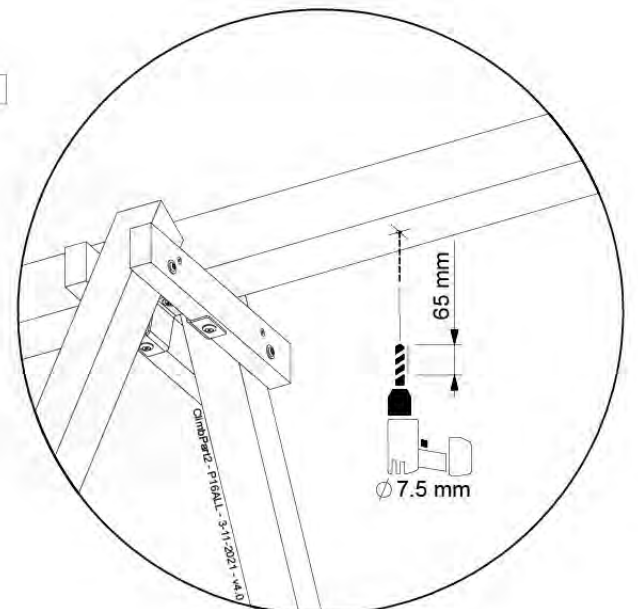
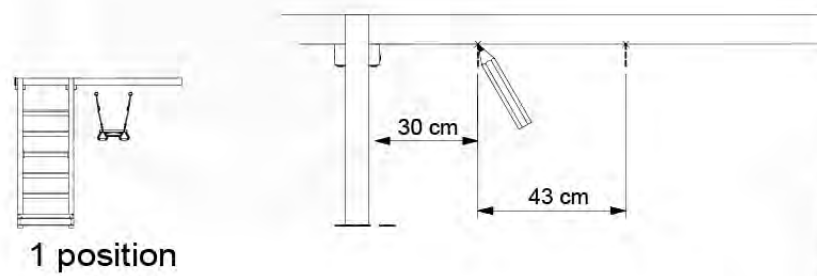
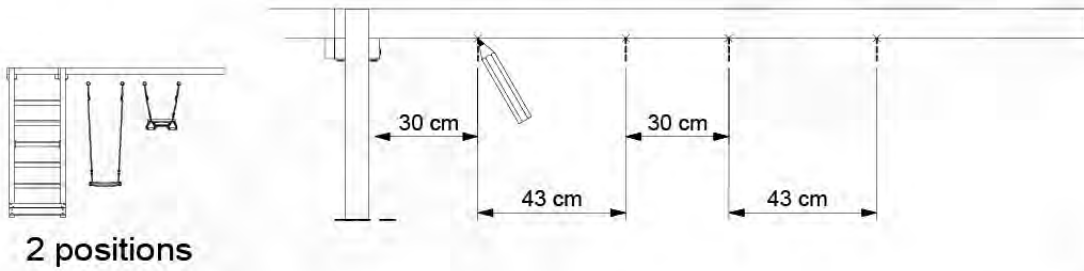

# 06-12

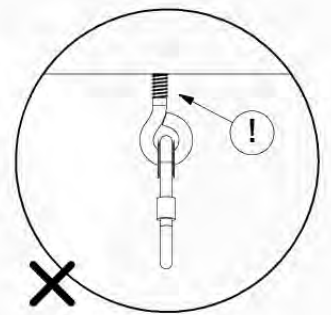
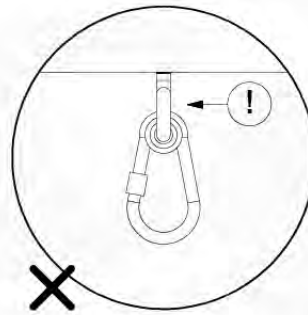
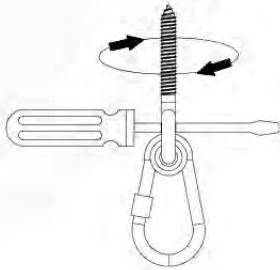
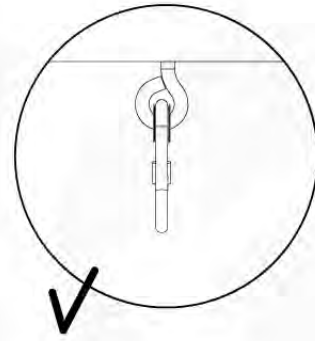
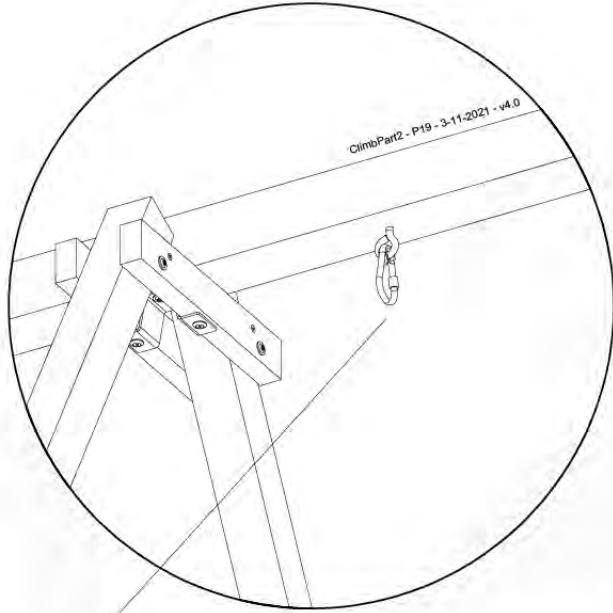

# 06-13

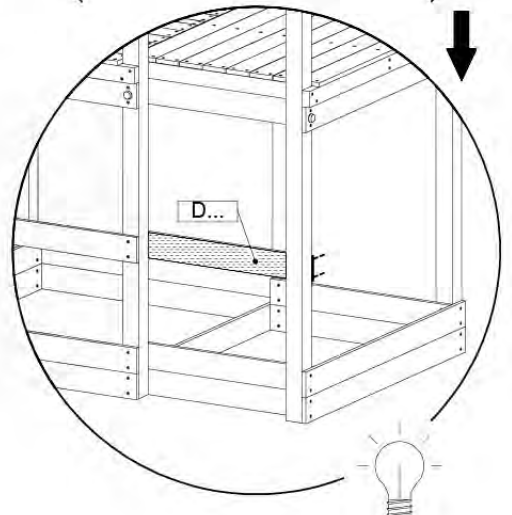
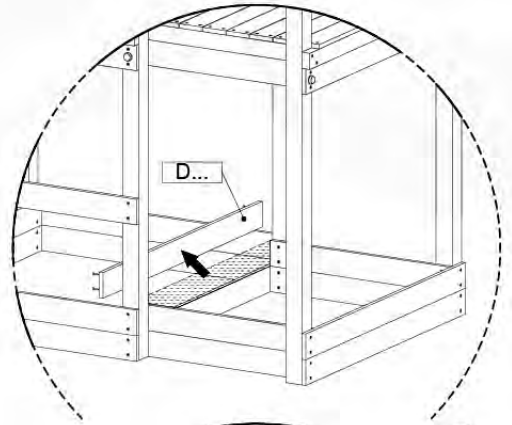
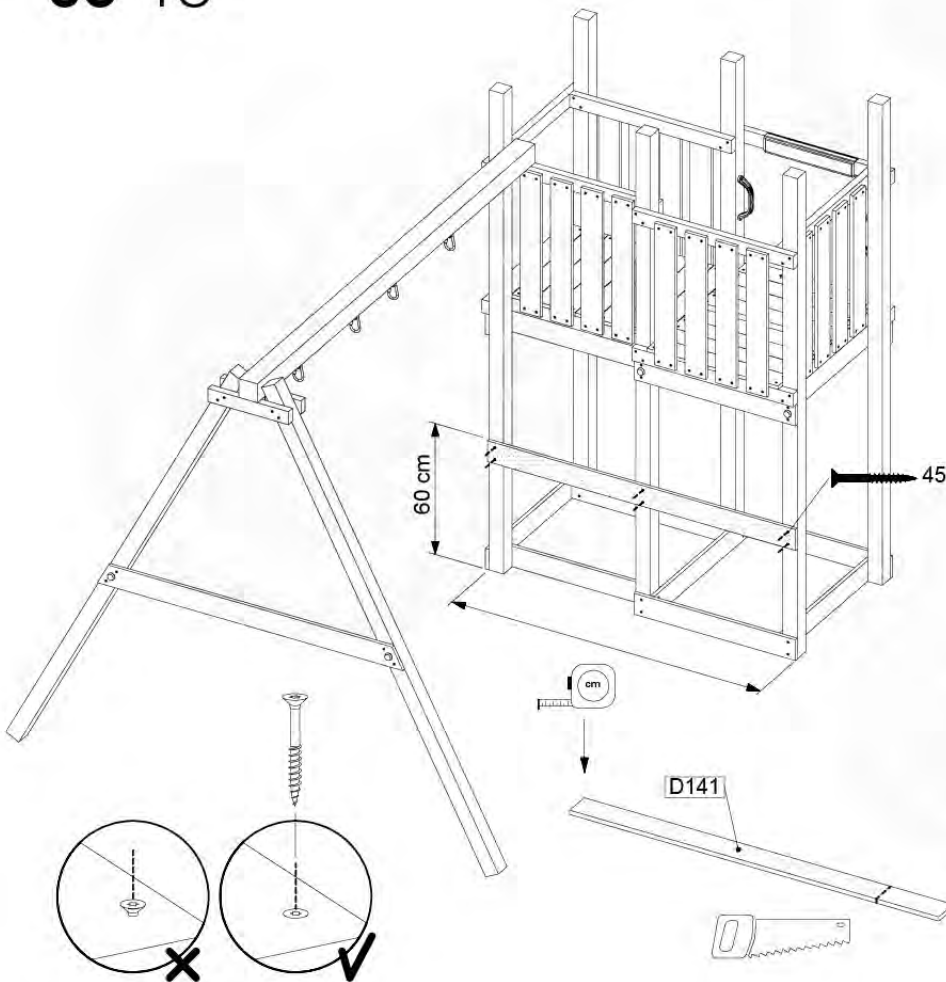



# 07-2



20 L / 40 kg

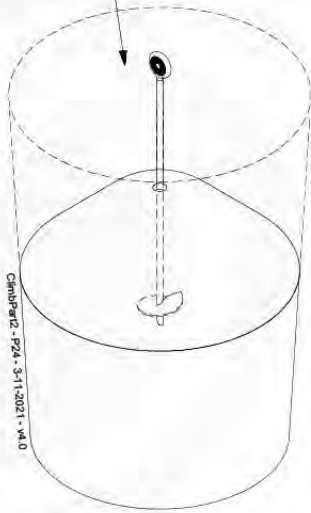

1.

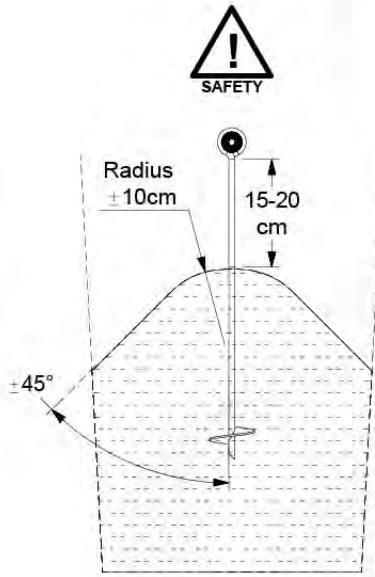

2.

24h



3.

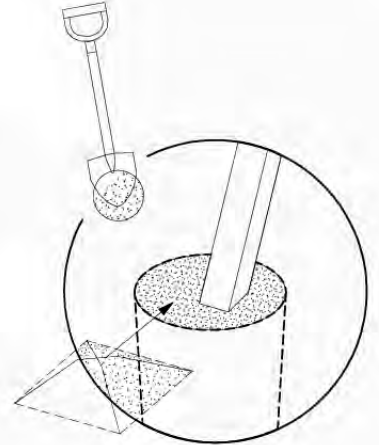

4.

# 08 Accessories

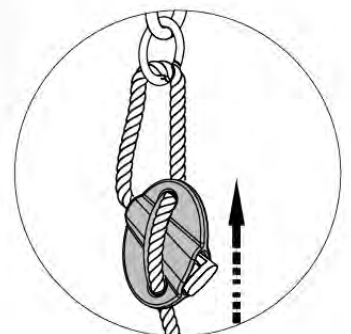
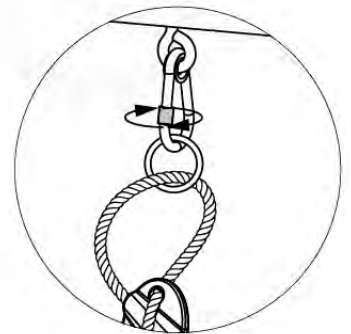
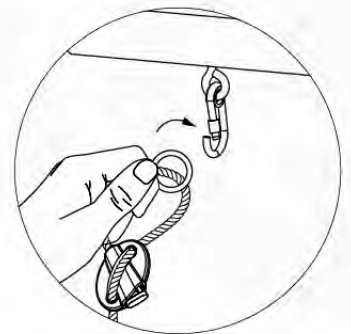
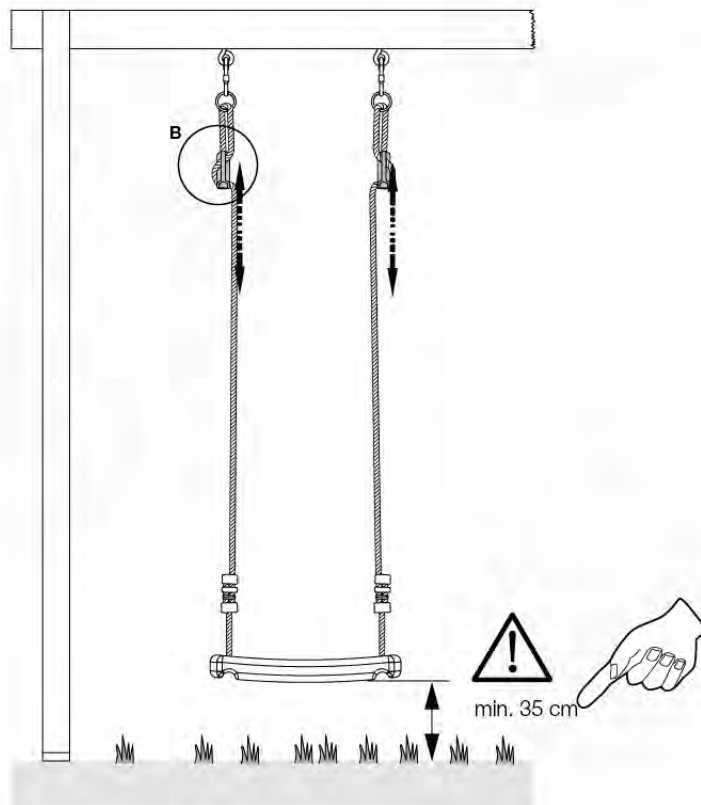

09

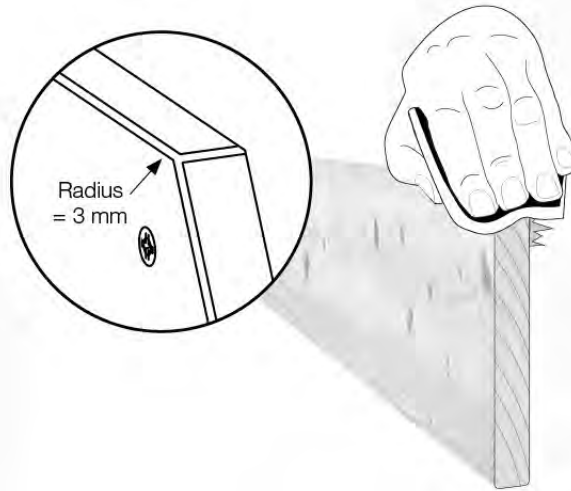

10

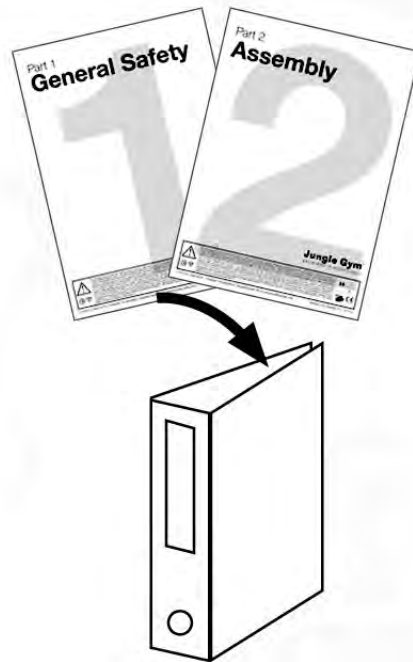



# Declaration of Conformity

# Jungle Gym

## BACKYARD PLAYGROUNDS

since 1988

### Manufacturer details

Company Name

Jungle Gym B.V.

Tag-line

Backyard Playgrounds

Address

P.O. Box 75083, 1070 AB Amsterdam, Netherlands

### Activity toys for domestic use

Product Range Identification

Sub-Assembly

Universal Packs / Base Towers / Extension Towers / Roofs / Means of Exit/Access / Add-ons : 790\_001 ... 794\_911

Assembly

Playtowers : 801\_005 ... 200

Links : 870\_100 ... 105

Accessories : 123\_220 ... 250\_075

Playhouses : 830\_150 ... 253, 835\_251 ... 253

Swings : 801\_300, \_600, \_601

Slides (XL) : 324\_100 ... 600

Modules : 850\_180 ... 415

Slides (XXL) : 334\_100 ... 600

: 857\_103, 857\_108

Playtowers : 802\_202 ... 208

857\_151, 857\_158

803\_202 ... 210

809\_202 ... 804

### Applicable EC directives and standards

Chemical References

1. Migration of certain elements (17x + Chr VI + tin) as required in TSD 2009/48/EC and its amendments. Scrape off toy material. Tested according to EN 71-3:2019.
2. Migration of solvents, monomers and plasticizers as specified in "Safety for Toys: Organic Chemical Compounds", EN 71-9: 2005 + A1: 2007. Tested according to EN 71-10: 2005 & EN 71-11: 2005.
3. Content of N-nitrosamines and N-nitrosatable substances as specified in EN standard 71-12: 2013. Tested according to EN 71-12: 2013.
4. Content of 18 PAHs (Polycyclic Aromatic Hydrocarbons) as referred in AfPS GS 2014:01 PAK (Replaced on 2019:01). Tested according to QMA 2011.1284
5. Content of 7 Phthalates (18x) according to REACH (EG) no.1907/2006, Annex XVII. Tested according to COC-CH-C1011-09.3 and EN 15777 / QMA 2011.1300
6. Content of Cadmium according to REACH (EG) no. 1907/2006, Annex XVII. Tested according to EN 17294-2
7. Formaldehyde according to REACH (EG) no. 1907/2006, Annex XVII. Tested according to EN 14184
8. Azo dyes according to REACH (EG) no. 1907/2006, Annex XVII. Tested according to BVL B 82.02-2.
9. Content of 3 Flame retardants according to REACH (EG) no. 1907/2006, Annex XVII. Tested according to EN 62321-6.
10. NI release according to REACH (EG) no. 1907/2006, Annex XVII. Tested according to EN 71-3:2013+A1:2014.
11. Sweat and Salvia resistance tested according to DIN 53160

Mechanical physical properties + flamability

EN 71 - 1 : 2014 + A1: 2018 EN 71 - 2 : 2011 + A1: 2014 EN 71 - 8 : 2018

### Supplementary information

Conformity to the above specified directives and standards has been frequently verified and is continuously monitored by TÜV Süd, TÜV Rheinland LGA products, DEKRA (DE), STR Ltd (UK), LNE SA (FR), LMR Ltd (US) and IPS N.V. (BE) since 1994. Jungle Gym participates in the European Commission for standardisation for the safety of activity toys ( TC52 / WG 10).

### Declaration

I hereby declare under our sole responsibility that the products mentioned above, to which this declaration relates, complies with the above mentioned directives and standards.



Name

Mr. P. Schmit / Director

























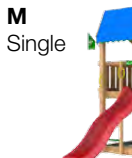

Issued date

Januari 2<sup>nd</sup>, 2023











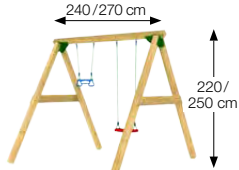

Signature of representative

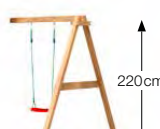
# Construction Packages (Assembly)

## Playtowers

<b>S</b> Single  <b>Jungle Tower</b> 802_201	<b>S</b> Single  <b>Jungle Patio</b> 802_202	<b>S</b> Single  <b>Jungle Cocoon</b> 802_204	<b>S</b> Single  <b>Jungle Cirque</b> 802_206	<b>S</b> Single  <b>Jungle Totem</b> 802_208	<b>S</b> Duo  <b>Jungle Nomad</b> 803_202	<b>S</b> Duo  <b>Jungle Safari</b> 803_204
<b>S</b> Duo  <b>Jungle Viking</b> 803_206	<b>S</b> Duo  <b>Jungle Teepee</b> 803_208	<b>S</b> Duo  <b>Jungle Resort</b> 803_210	<b>S</b> Combo  <b>Jungle Explorer</b> 809_802	<b>S</b> Combo  <b>Jungle Voyager</b> 809_804	<b>M</b> Single  <b>Jungle Castle</b> 801_120	
<b>M</b> Single  <b>Jungle Club</b> 801_110	<b>M</b> Single  <b>Jungle Casa</b> 801_105	<b>M</b> Single  <b>Jungle Home</b> 801_103	<b>M</b> Single  <b>Jungle Hut</b> 801_100	<b>M</b> Single  <b>Jungle House</b> 801_095	<b>L</b> Single  <b>Jungle Cottage</b> 801_090	<b>L</b> Single  <b>Jungle Cabin</b> 801_060
<b>L</b> Single  <b>Jungle Lodge</b> 801_040	<b>L</b> Duo  <b>Jungle Cubby</b> 801_070	<b>L</b> Duo  <b>Jungle Mansion</b> 801_009	<b>XL</b> Single  <b>Jungle Sierra</b> 801_025	<b>XL</b> Single  <b>Jungle Fort</b> 801_010	<b>XL</b> Duo  <b>Jungle Chalet</b> 801_013	<b>XL</b> Duo  <b>Jungle Palace</b> 801_005

## Swings

 <b>Jungle Peak</b> 801_300	 <b>Jungle Swing</b> 801_601/602	 <b>1-Swing Module 200</b> 857_101	 <b>2-Swing Module 200</b> 857_102	 <b>1-Climb Module 200</b> 857_105	 <b>2-Climb Module 200</b> 857_106
		 <b>1-Swing Module 220</b> 857_151	 <b>2-Swing Module 220</b> 857_154	 <b>1-Climb Module 220</b> 857_157	 <b>2-Climb Module 220</b> 857_158
 <b>Bridge Module</b> 850_240		 <b>1-Swing Module 220 Extra</b> 850_176	 <b>2-Swing Module 220 Extra</b> 850_177	 <b>1-Climb Module 220 Extra</b> 850_231	 <b>2-Climb Module 220 Extra</b> 850_232

## Modules

# Construction Packages (Sub-Assembly)

## Universal Packs (AC)

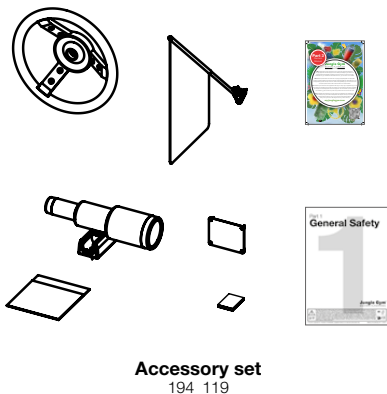

**Accessory set**  
194\_119

## Base Towers (BT)

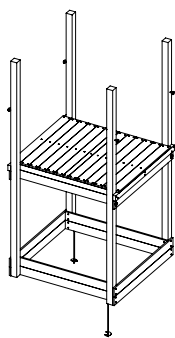

**Tower 80**  
790\_001  
790\_002  
790\_003  
790\_005

**Tower 115**  
792\_001  
792\_002  
792\_003

**Tower 140**  
794\_001

## Extension Towers (ET)

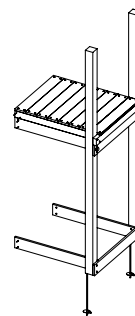

**Tower 80**    **Tower 140**  
790\_101    794\_102  
790\_102    794\_103  
794\_104

**Tower 115**  
792\_101    794\_105  
792\_102    794\_106  
792\_103    794\_108  
792\_104    794\_109  
792\_105    794\_110  
792\_106  
792\_107  
792\_108  
792\_109  
792\_110  
792\_111  
792\_112  
792\_113  
792\_114

## Roofs (RF)

### Roof tarp

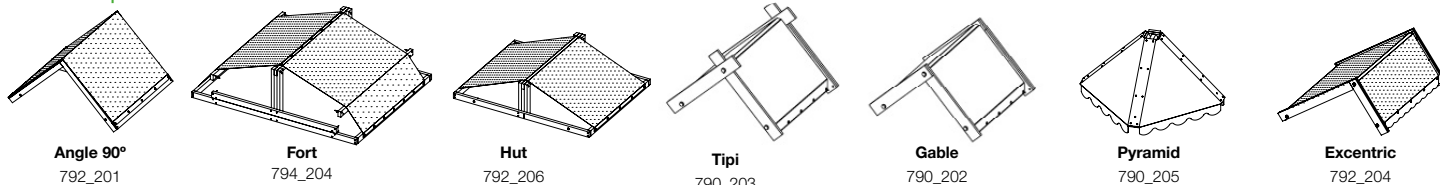

**Angle 90°**  
792\_201

**Fort**  
794\_204

**Hut**  
792\_206

**Tipi**  
790\_203

**Gable**  
790\_202

**Pyramid**  
790\_205

**Excentric**  
792\_204

### Roof wood

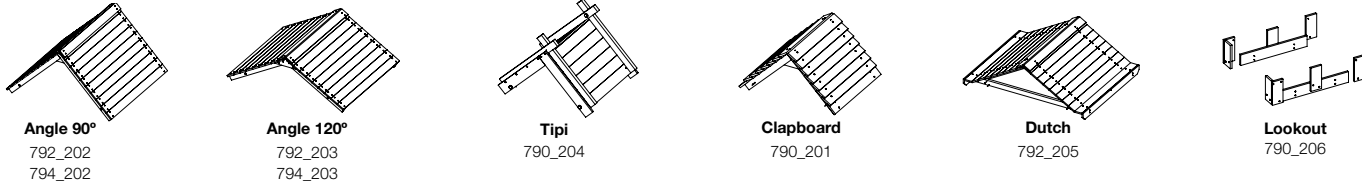

**Angle 90°**  
792\_202  
794\_202

**Angle 120°**  
792\_203  
794\_203

**Tipi**  
790\_204

**Clapboard**  
790\_201

**Dutch**  
792\_205

**Lookout**  
790\_206

## Means of Exit/Access

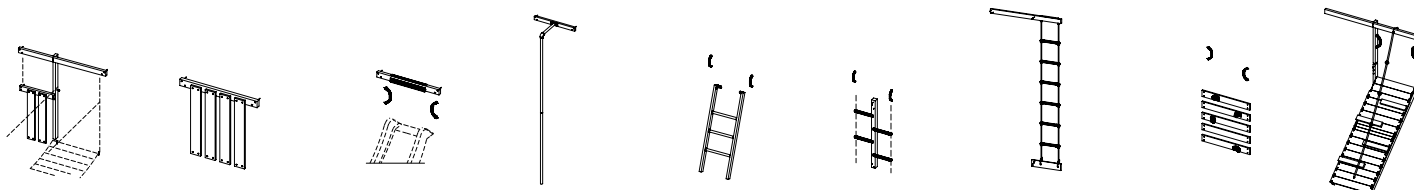

**Bridge Frames**  
**BF**  
792\_602  
794\_602

**Balustrades**  
**BL**  
790\_301  
792\_301  
794\_301  
794\_302

**Slides**  
**SL**  
790\_901  
792\_901  
792\_902  
792\_903  
794\_901

**Firemans Poles**  
**FP**  
790\_903  
792\_911  
792\_912  
792\_913  
794\_911

**Ladder**  
**LA**  
790\_433  
790\_434  
792\_431  
792\_432  
794\_431  
794\_432

**Two Step Ladder**  
**TS**  
790\_413  
790\_414  
792\_411  
792\_412  
794\_411  
794\_412  
794\_413  
794\_414

**Rope ladder**  
**RL**  
790\_421  
792\_421  
792\_422  
794\_421

**Rock wall**  
**RW**  
790\_403  
790\_404  
792\_401  
792\_402  
794\_401  
794\_402

**Ramp**  
**RA**  
790\_441  
792\_441  
794\_441

## Add-ons

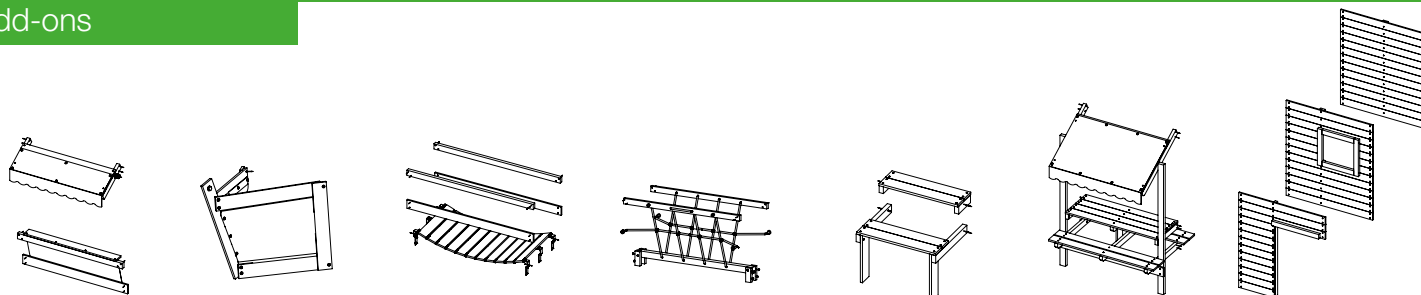

**Market**  
**MT**  
790\_502  
792\_502  
794\_502

**Boat front**  
**BO**  
790\_501

**Clatter bridge 80**  
**CB**  
790\_601

**Net bridge 80**  
**NB**  
790\_611

**Picnic 80**  
**PC**  
790\_503

**Picnic 115/140**  
**PC**  
792\_503  
794\_503

**Playhouse panels**  
**PH**  
790\_311    794\_311  
792\_313    794\_312  
792\_311    794\_313  
792\_312    794\_314  
792\_313  
792\_314

# Construction Packages (accessorie-assembly)

## Imagination



**Steering Wheel Yellow**  
201\_280



**Fun Phone**  
201\_285



**StarOscope™**  
201\_290



**Steering Wheel Boat**  
202\_473



**PeekOscope™**  
201\_295

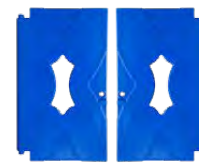

**Shutters 2x blue**  
250\_075



**Tic Tac Toe**  
450\_310

**Bucket**  
450\_320



**Talking Tube™**  
450\_330

### Wavy Star Slide XL

- 324\_100 Yellow
- 324\_200 Blue
- 324\_300 Green
- 324\_400 Red
- 324\_500 Fuchsia
- 324\_600 Dark Green

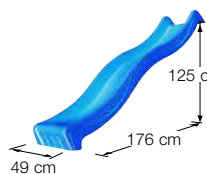

### Wavy Star Slide XXL

- 334\_100 Yellow
- 334\_200 Blue
- 334\_300 Green
- 334\_400 Red
- 334\_500 Fuchsia
- 334\_600 Dark Green

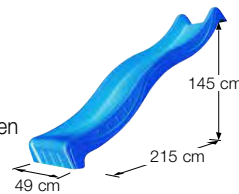

## Swinging



**Sling Swing Kit Yellow**  
250\_001



**Monkey Bar Kit Blue**  
250\_013



**Baby Swing Kit Red**  
250\_025



**Swing Seat Kit Red**  
250\_034



**Twist Disk Kit Green**  
250\_053

## Climbing



**AP Two Step Ladder 80**  
194\_102



**AP Step Ladder 80\_125**  
194\_103



**AP Step Ladder 80\_145**  
194\_104



**AP Rock-Wall 80\_125**  
194\_105



**AP Rope Ladder**  
194\_115



**AP Clatter Bridge**  
194\_116



**Climbing Rope**  
201\_060



**Fireman's Pole**  
201\_275



**Gymnastics bar**  
201\_273

## Functional



**Canvas blue/green**  
123\_220 ±136x 74cm  
123\_222 ±185x120cm



**Mesh green**  
123\_230



**Swing Hook Screw 2x**  
201\_115



**Bolt Caps 10x / 40x**  
White □ 202\_620 202\_629  
Yellow ■ 202\_621 202\_625  
Blue ■ 202\_622 202\_626  
Green ■ 202\_623 202\_627  
Red ■ 202\_624 202\_628



**Bumper Pad (2pcs)**  
202\_824

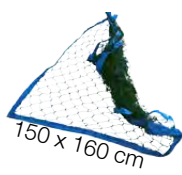

**Cat Stop™**  
201\_220



**Handgrips**  
■ 201\_250 Yellow  
■ 201\_260 Blue  
■ 201\_270 Green

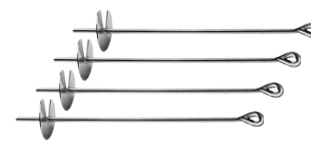

**Ground Anchors**  
250\_070