

1D

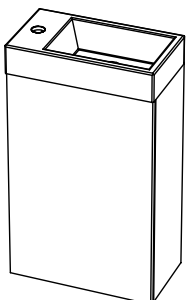

1a

V1

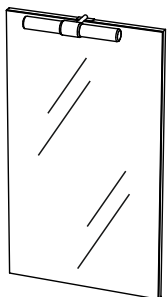
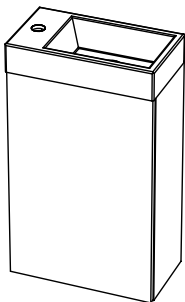
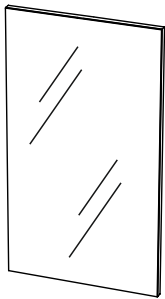
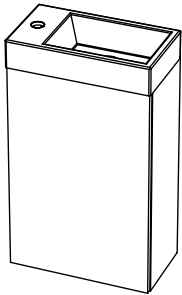
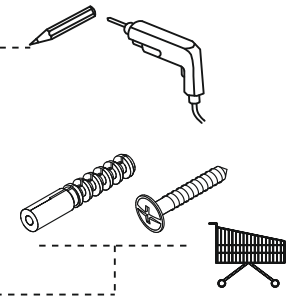
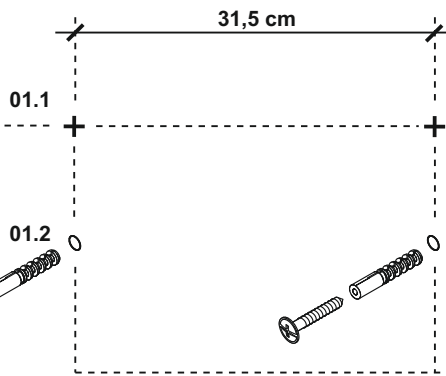
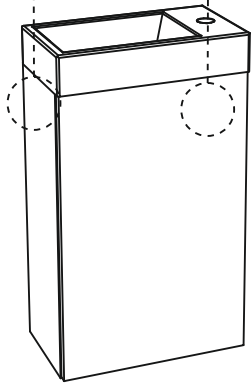

1b

V2 V3

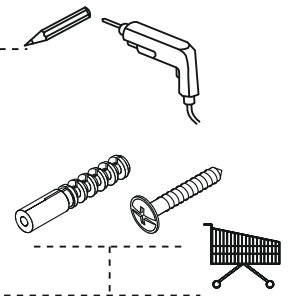
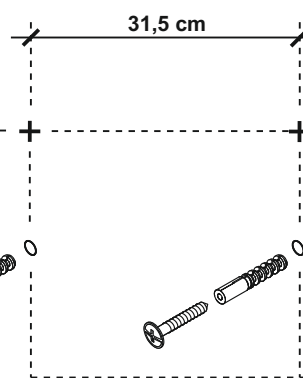
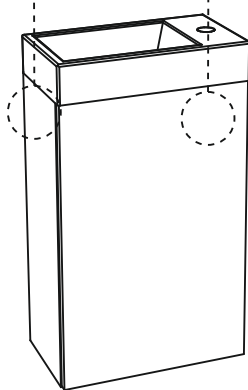
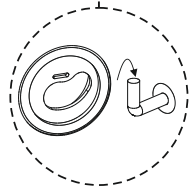
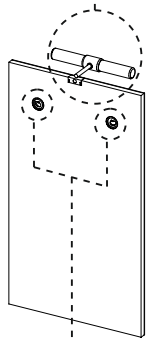
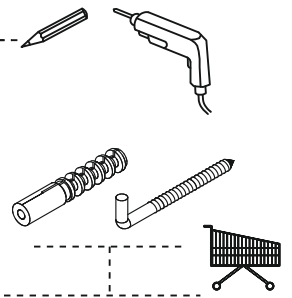
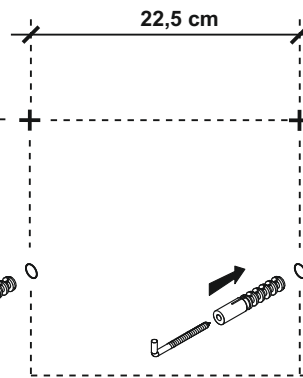
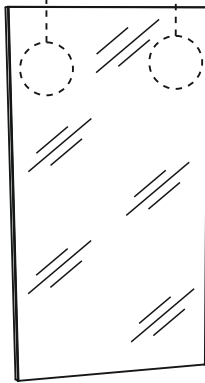
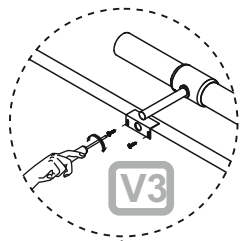

1c

V1 V2 V3

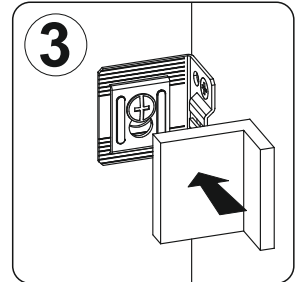
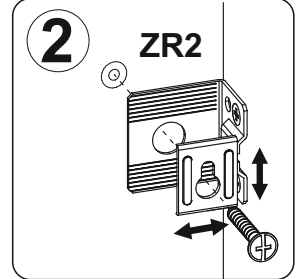
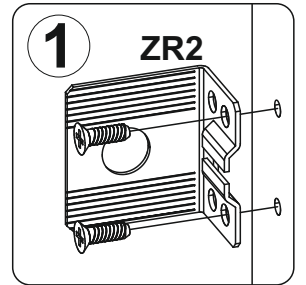
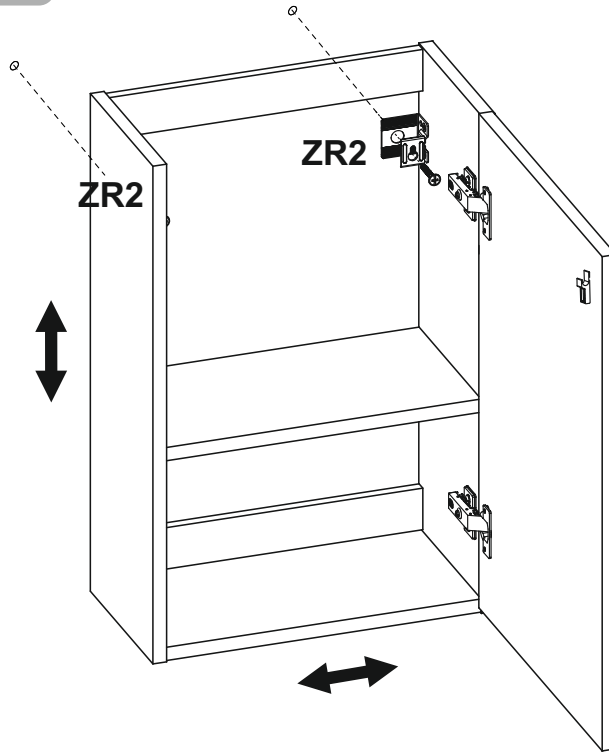
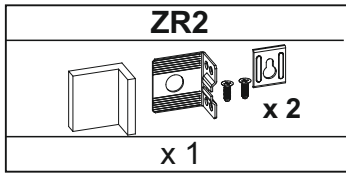

2

V1 V2 V3



03.

04.



05.

03.

04.

3

V1 V2 V3

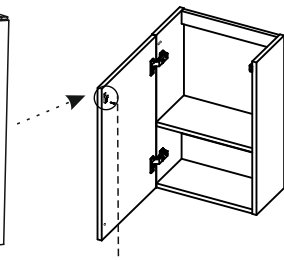
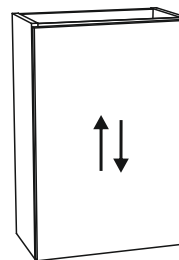
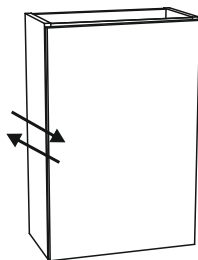
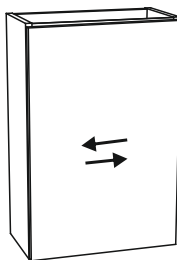

I2

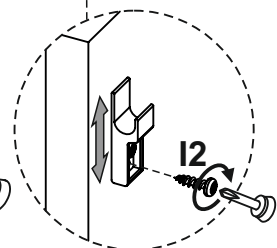
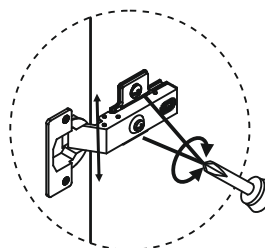
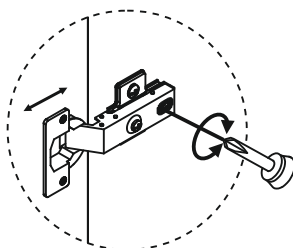
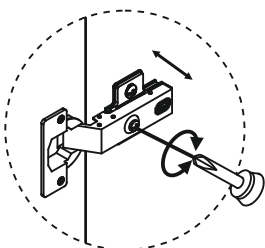
UP3x12
x 1



4

V1

V2

V3

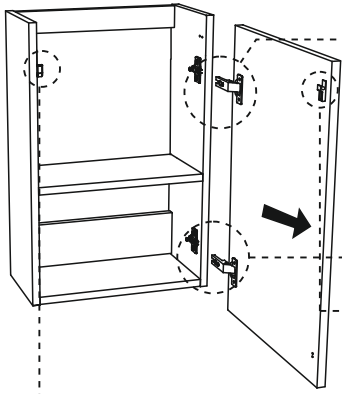

5.1

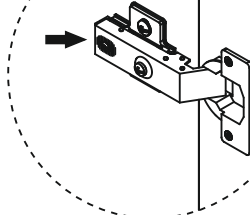

5.2

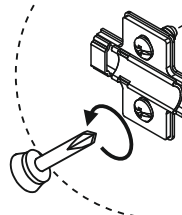

5.3

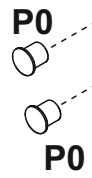

5.5

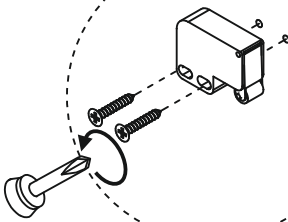

5.4

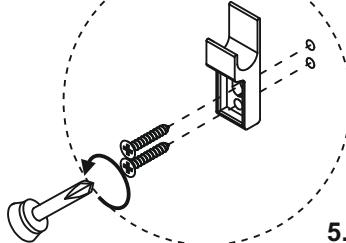

5.6

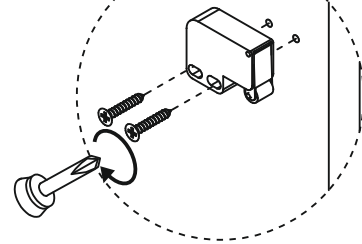

5.7

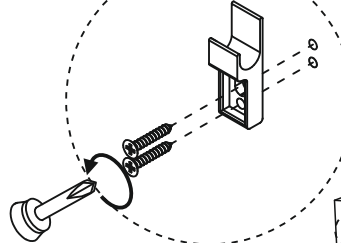

5.8

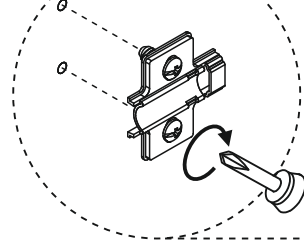

5.9

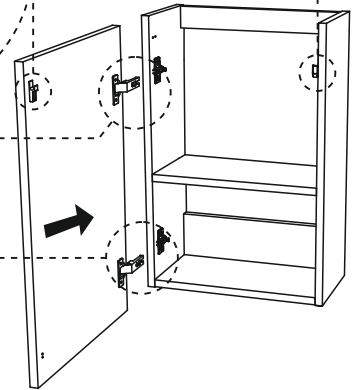
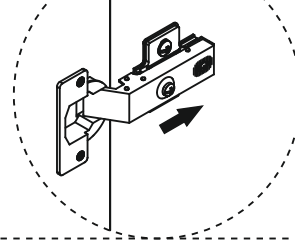

P0



x 4

5

V1

V2

V3

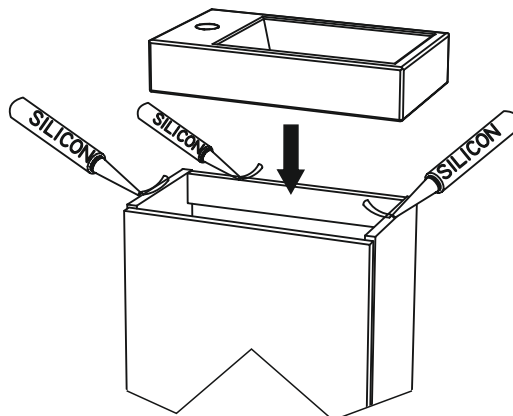

Karta Gwarancyjna
Warranty card
Garantiekarte



Formularz zgłoszenia reklamacji
Complaint submission form
Formular für die Einreichung von Beschwerden



Filmy instruktażowe
Tutorial videos
Lehrvideos