

FAVORI

Item number: 09438/01/31
 EAN code: 54 11212093226

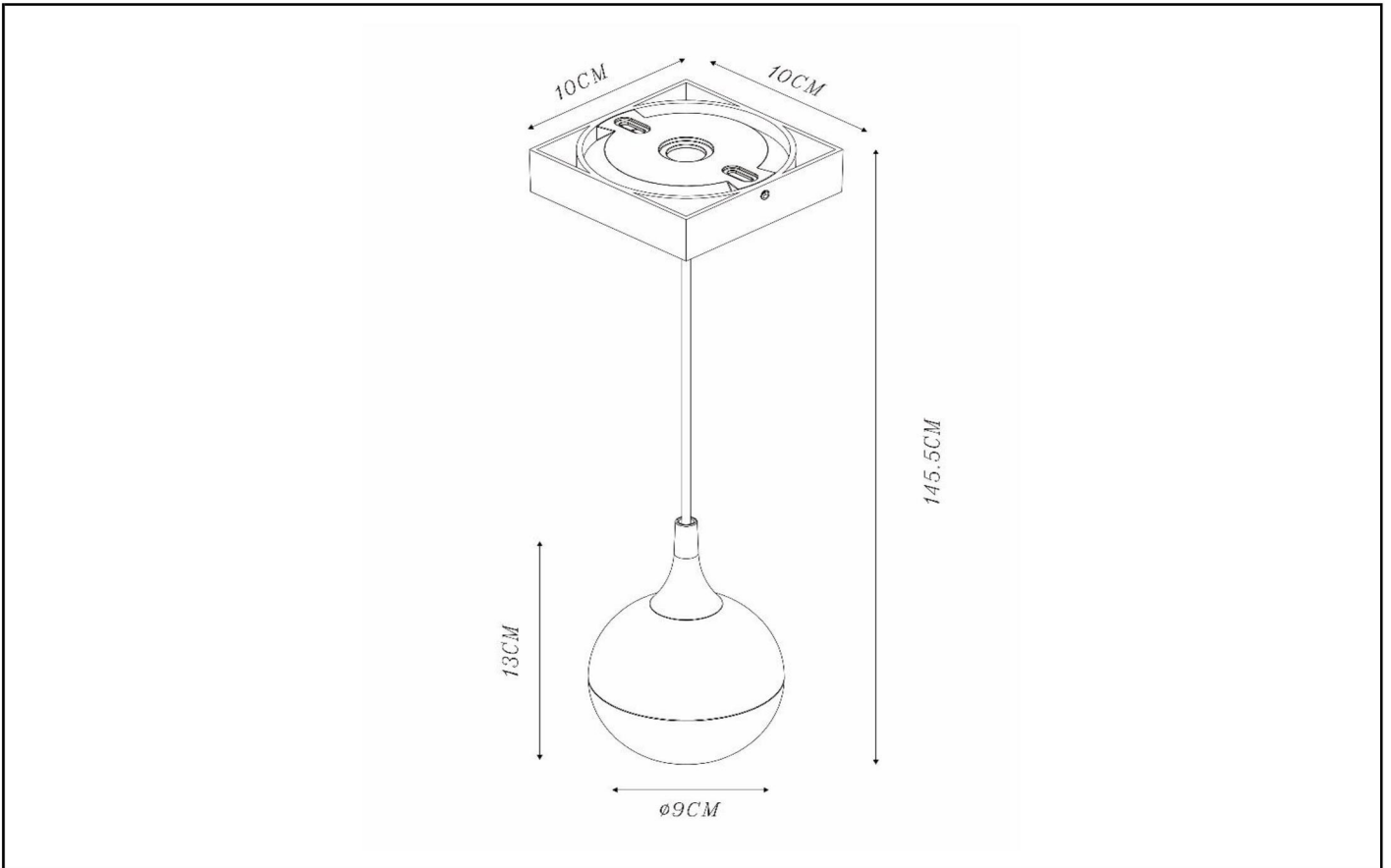

Installation of items in bathroom:



The explanation of the IP ratings can be found in the safety instructions.

For more specifications or dimensions of this product please visit www.lucide.com