

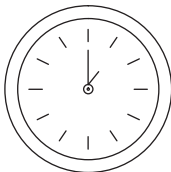









1

 <p>5 min</p>	 <p>1x</p>
--	---

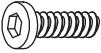
2a

A  Ø6*Ø16*1.2mm 4x	B   M6*50mm 4x	C   M6*30mm 4x	D  5mm 1x
---	---	--	--

2b

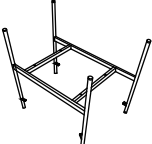
1  1x	2  1x	3  1x
---	---	--

1

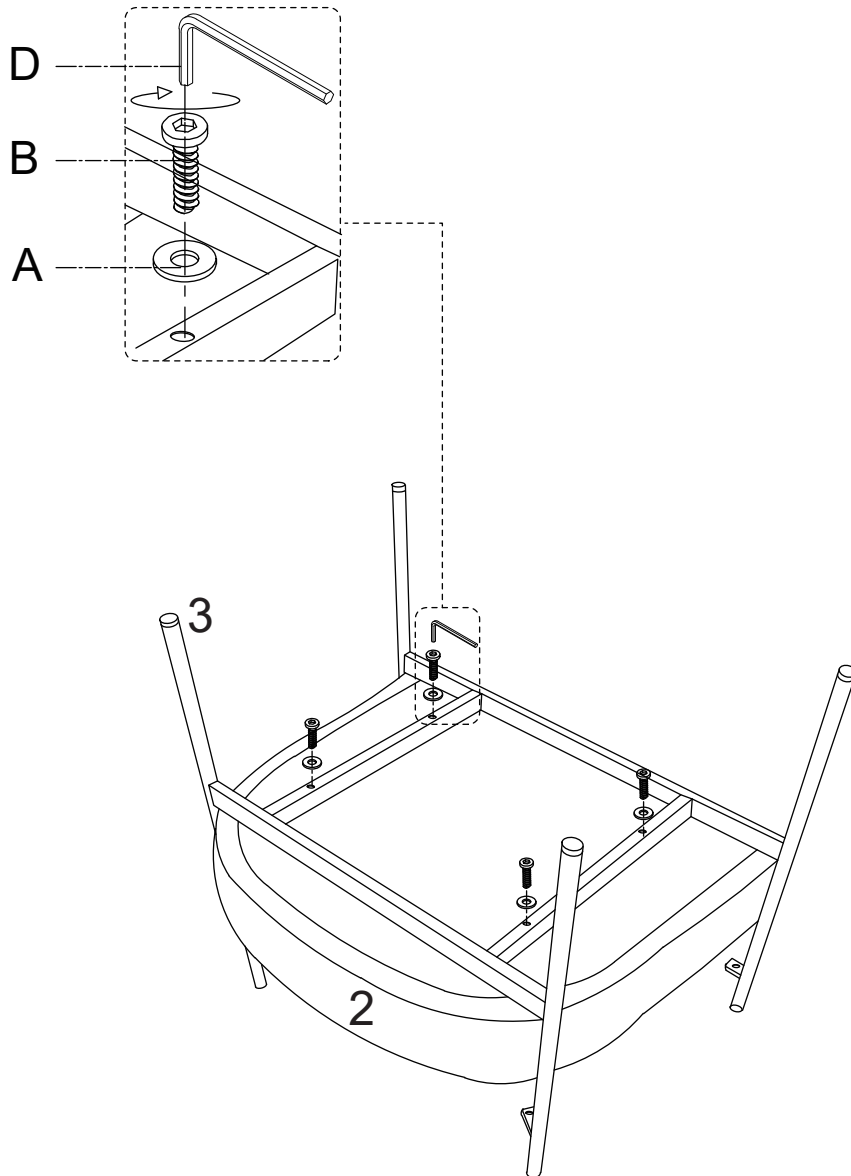

A



$\text{Ø}6 \times \text{Ø}16 \times 1.2\text{mm}$
4x

B



M6*50mm
4x

D



5mm
1x

2

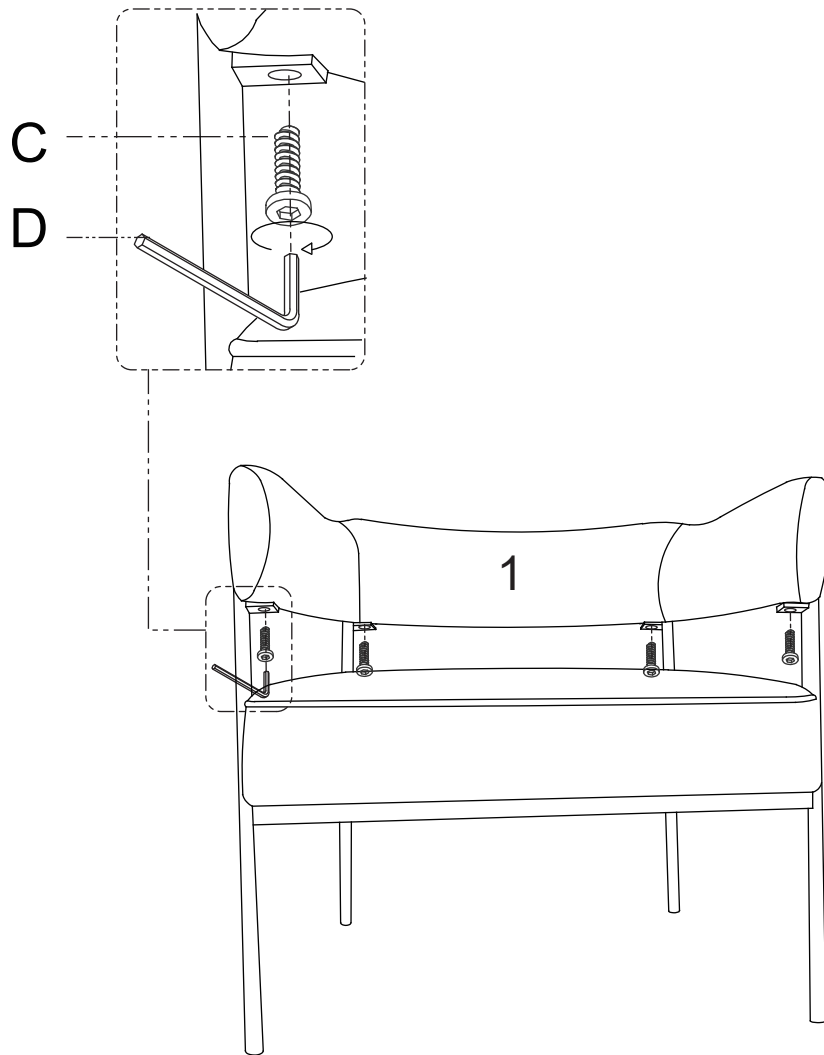

C

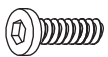

M6*30mm
4x

D



5mm
1x

3

