

Dillon 540
Art. Nr. 1009539 / 3415450

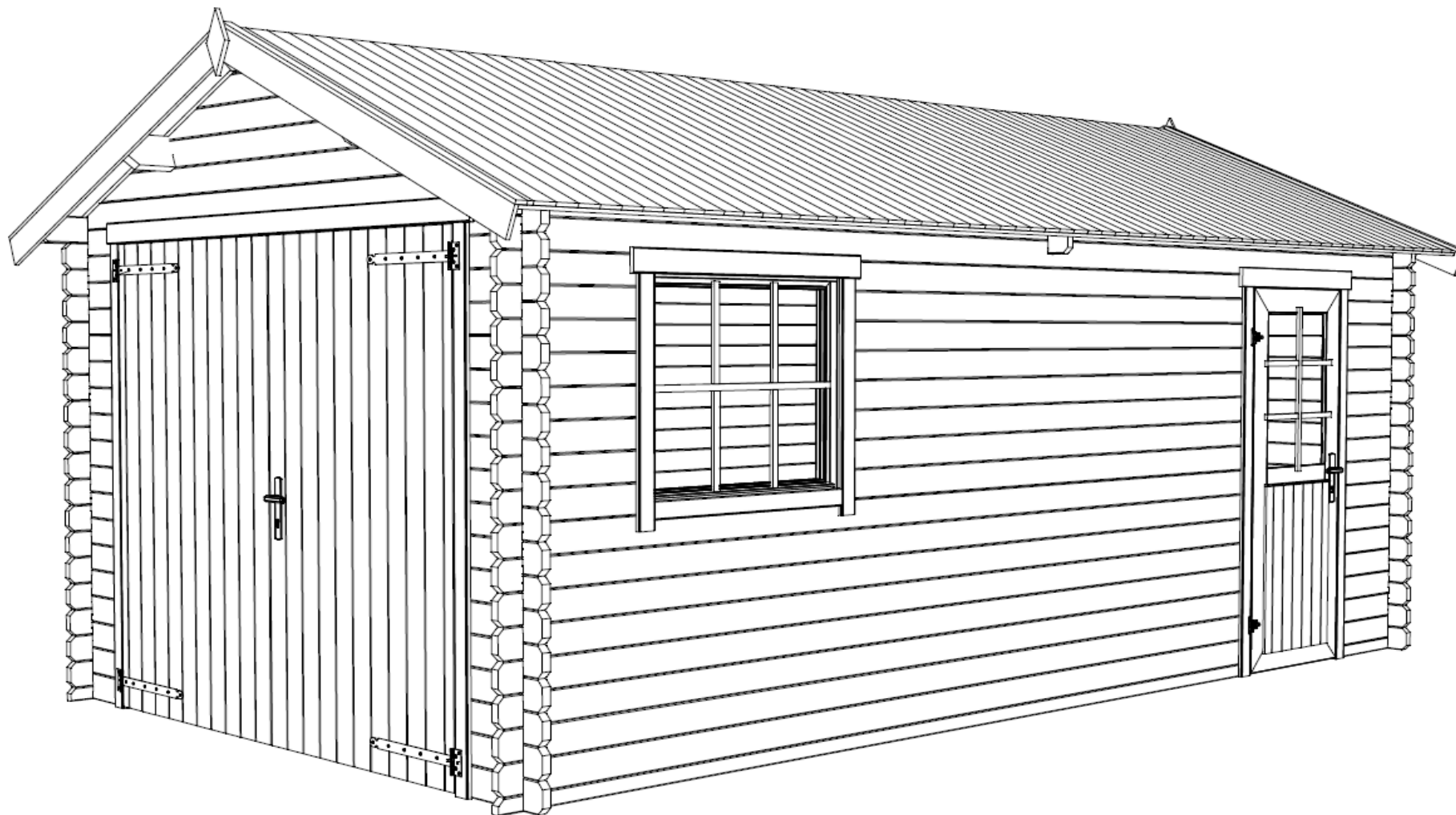

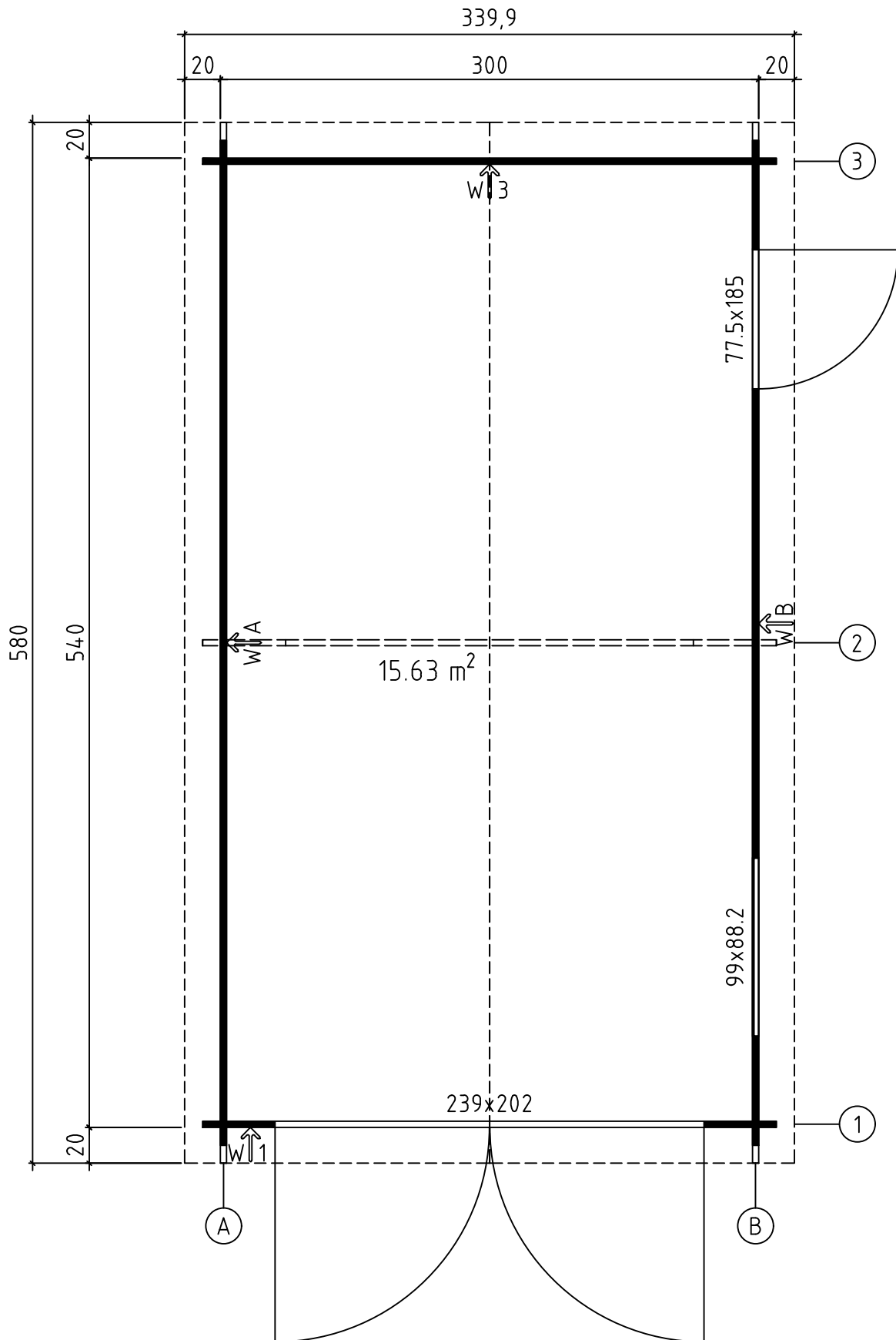



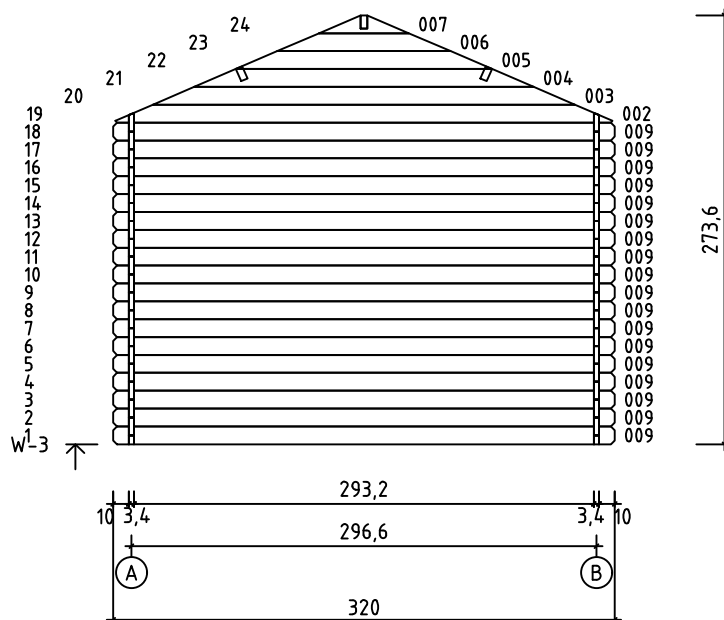
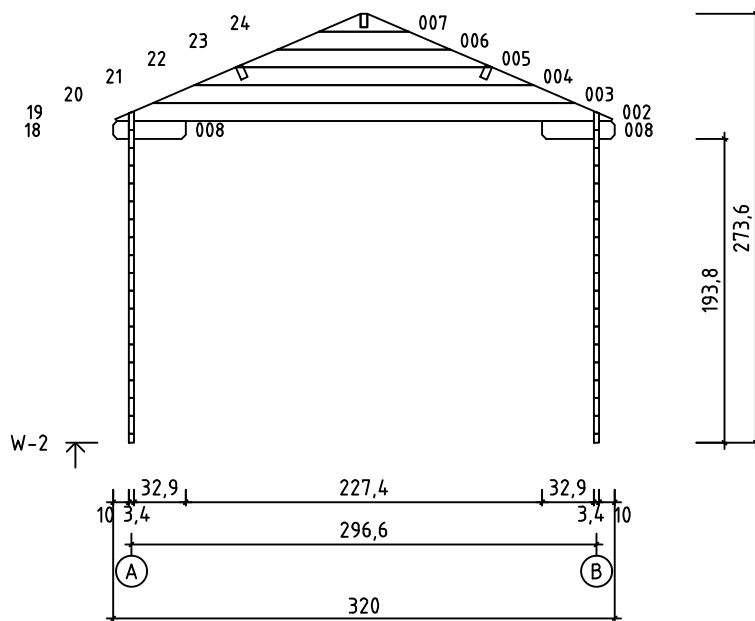
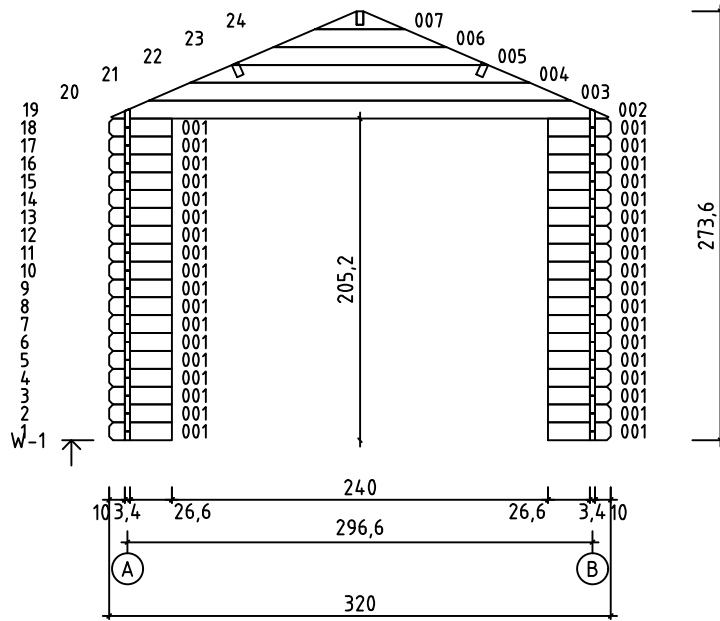

1/9



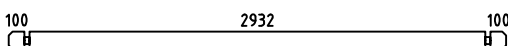
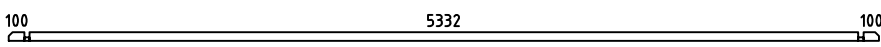
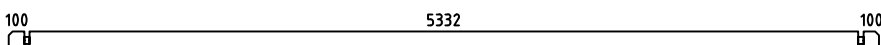
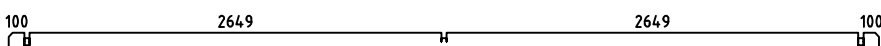
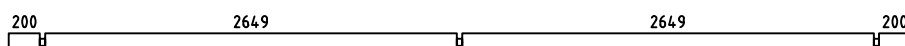
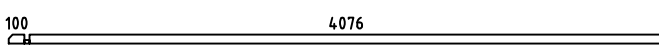
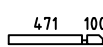
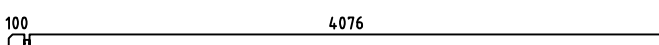
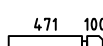
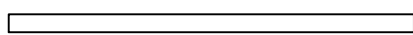
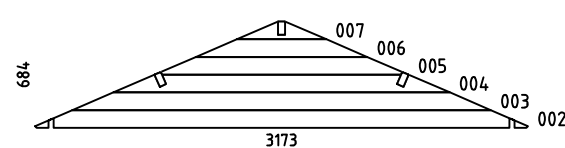
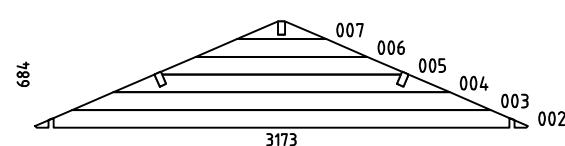
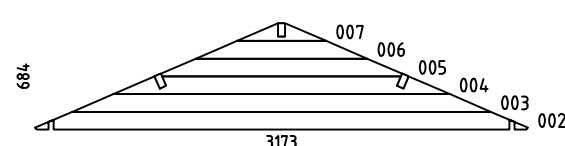

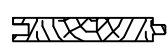

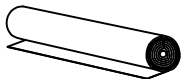



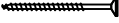
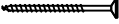
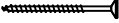
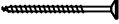
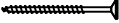
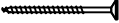
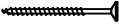
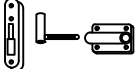
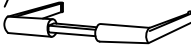

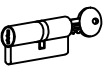
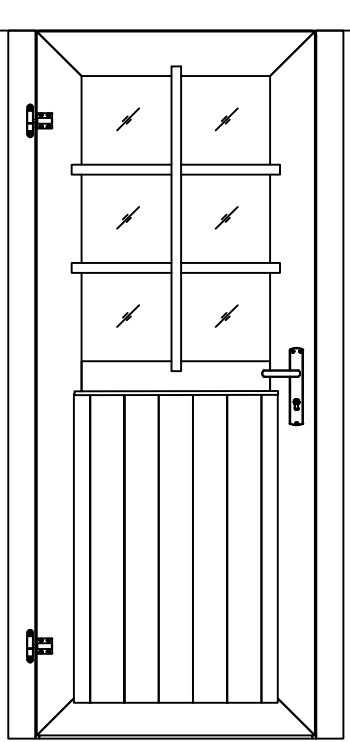
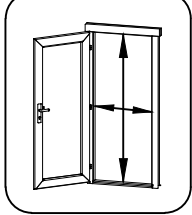
Groundplan - Grundplan - Plan de masse - Planimetria - Plattegrond - Põhiplaan

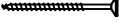
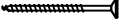
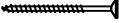
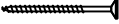
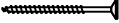
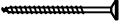

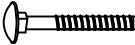
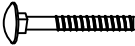

Pos	18.09.2017 Piece list - Stückliste - Liste des pièces - Elementi - Stuklijst - Tükítabel Art.Nr. 3415450 5/9	Q	P (mm)	L (mm)
001		36	34x114	400
008		2	34x114	463
009		18	34x114	3200
010		1	34x57	5600
011		16	34x114	5600
012		2	34x114	5600
013		2	34x120	5800
014		1	34x57	4210
015		1	34x57	605
016		8	34x114	4210
017		24	34x114	605
018		8	34x114	2607
W1-1		1		
W2-1		1		
W3-1		1		
A-PR1	Roof beam - Dachbalken - Panne de toit - Perlina del tetto - Gordingen / dakbalk - Pärilin 	3	44x140	5800
	Roof boards - Dachbretter - Voliges - Perlina per tetto - Dakhout - Katuselaud 	130	90x15	1850
	Roofing felt fillet - Dachpappenleiste - Baguette de fixation du feutre bitumeux - Asse per fissaggio guaina bituminosa - Afdeklijst asfaltpapier - Katusepapiilist 	4	15x45	1900
DPP-1	Roofing felt (strip) - Dachpappe (bahnen) - Feutre bitumeux (bande) - Cartone catramato - Asfaltpapier (baan) - Katusepapp 	5		5900
DRV-1	Roof edge reinforcement - Dachrandverstärkung - Corniere de renfort de bord de toit - Rinforzo x tetto - Dakrand versterking - Räästatugevdus 	4	15x45	2900

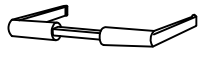
Pos	18.09.2017	Piece list - Stückliste - Liste des pièces - Elementi - Stuklijst - Tükítabel 775x1850 UK.2.056.SVV.MMX28 SGA+28	7/9	Q	P (mm)	L (mm)
HS1		Screw for georgian bars - Schraube für sprossen - Vis pour croisillons - Viti per unire la griglia georgiana della finestra - Schroeven voor raamverdeling - Kruvi ukse petfeliistule		6	2.5x20	
HS9		Screw for fixing door to the wall - Schraube zur befestigung für - zarge mit wand - Vis de fixation partie dormants de porte au 1er rang de madrier - Viti per fissare la porta alla parete - Schroef voor bevestiging deur naar wand - Kruvi ukse selengi kinnifamiseks seinale		2	3.5x50	
HS11		Screw for fixing bolt hinge - Schraube für türband - Vis pour fixation gonds de porte - pour ouvrant - Viti per fissaggio cardini e cerniere della porta - Schroef voor scharnier - Kruvi ukse polthingele		8	4x30	
HS12		Screw for fixing bolt hinge - Schraube für türband - Vis pour fixation gonds de porte - pour ouvrant - Viti per fissaggio cardini e cerniere della porta - Schroef voor scharnier - Kruvi ukse polthingele		6	4x40	
HS13		Screw for door jamb - Schraube für türrahmen - Vis de fixation partie haute avec montants du cadre de porte - Viti x fissaggio montanti porte - Schroef voor deurkozijn - Kruvi ukse lengile		2	4x60	
HS16		Screw for door jamb - Schraube für türrahmen - Vis de fixation partie haute avec montants du cadre de porte - Viti x fissaggio montanti porte - Schroef voor deurkozijn - Kruvi ukse lengile		2	5x90	
HS25		Screw for doorstep - Schrauben für swelle - Vis pour fixation barre de seuil - Vite per soglia della porta - Schroef voor deurdorpel - Kruvi lävepakule		2	4.5x65	
		Male bolt hinge for door - Türband - Partie male de paumelle de porte - Cerniera anube x porta - Scharnier bout - Polthing adapteriga DIN15-57		2		
TL4		Door handle fittings - Türgriff - Poignee de porte - Maniglie - Deurhendel / klink - Ukse käepide		1		
TL5		Set of door lock covers - Schlossblenden - Set de garnitures de porte - Copertura serrature - Slot sluitplaat set - Ukse lukuplaat		1		
		Cylinder lock - Zylinderschloss - Barillet de porte - Serratura - Cylinder slot - Ukse lukusüdamik		1	30x30	
<p>Glass size - Glasgröße - Taille de la vitre - Misura del vetro - Glas afmeting - Klaasi mõõt: 502x750 mm</p> <div style="display: flex; justify-content: space-around; align-items: center;">  <div style="text-align: center;">  <p>702x1793 mm</p> </div> </div>						

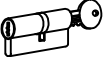
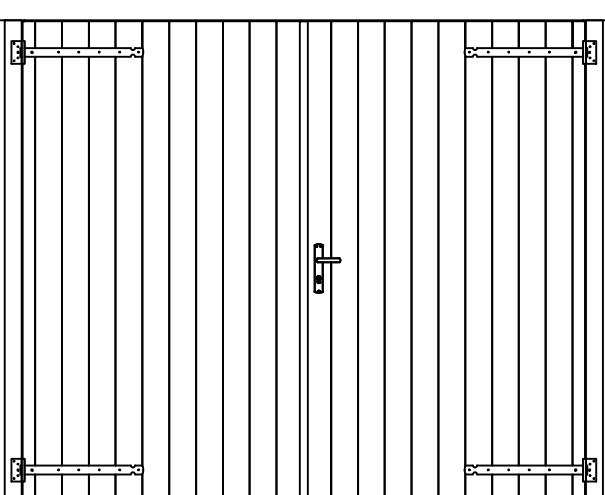
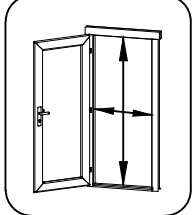
Pos	18.09.2017	Piece list - Stückliste - Liste des pièces - Elementi - Stuklijst - Joonis 2390x2020 TUL.2.100.IVP.TC	8/9	Q	P (mm)	L (mm)	
HS9	Screw for fixing door to the wall - Schraube zur Befestigung für - zarge mit wand - Vis de fixation partie basse dormantis de porte au 1er rang de madrier - Viti per fissare la porta alla parete - Schroef voor bevestiging deur naar wand - Kruvi ukseleongi kinnitamiseks seinale		4	3.5x50			
HS4	Screw for door fillet - Schraube zur Befestigung türleiste - Vis pour fixation baguette d'arret de porte - Viti per massellino della porta - Schroef voor deurlijst - Kruvi ukse kokkuvaltssiliistule		6	3x30			
HS10	Screw for latch bolt for gate - Schraube für doppeltürfeststellriegel - Vis de fixation des loquets de fermeture pour porte double vantaux - Vite per il fermo della porta - Schroef voor dubbele deur vergrendelingsbout - Kruvi riivile		12	4x25			
HS12	Screw for latch answer - Schraube für einrasten antwort - Vis pour fixation partie reception loquet haut de porte - Contro vite per il fermo - Schroef tbv vergrendeling - Kruvi riivi vastusele		2	4x40			
HS16	Screw for door jamb - Schraube für türrahmen - Vis de fixation partie haute avec montants du cadre de porte - Viti x fissaggio montanti porte - Schroef voor deurkozijn - Kruvi ukse lengile		2	5x90			
HS19	Screw for gate hinges - Schrauben für torriegel - Vis pour fixation charniere de porte - Viti per cerniere del cancello - Schroef voor poort scharnier - Kruvi T-hingedele		36	6x40			
SFS	Nut for gate hinges - Schraubenmutter für torriegel - Ecrou pour les charniere de porte - Dado per cerniere delle porte - Moer voor poort scharnier - Mutter T-hingele		8	D6			
BFS	Bolt for gate hinges - Bolzen für torriegel - Boulon pour charniere de porte - Bullone per cerniere di porte - Scharnier bout - Puidupolt T-hingele		4	6x100			
BFS	Bolt for gate hinges - Bolzen für torriegel - Boulon pour charniere de porte - Bullone per cerniere di porte - Scharnier bout - Puidupolt T-hingele		4	6x60			
TL	Latch bolt for double door - Türriegel - Loquet pour double porte - Scrocco per porta doppia - Nachtslot - Riiv		2				
	Latch answer - Einrasten antwort - Partie de reception du loquet haut de porte - Contro fermo della chiusura della porta - Sluitbeugel plaatgrendel - Riivi vastus		1				
	Washer for gate hinges - Dichtscheibe für torriegel - Rondelle pour charniere de porte - Rondella per cerniera della porta - Afdichtring voor poortscharnier - Seib T-hingele		8	D6			
	Door hinges - Torriegel - Charniere de porte - Cerniere - Deur scharnier - T-hing		4				
TL4	Door handle fittings - Türgriff - Poignee de porte - Maniglie - Deurhendel /klink - Ukse käepide		1				
TL5	Set of door lock covers - Schlossblenden - Set de garnitures de porte - Copertura serrature - Slot sluitplaat set - Ukse lukuplaat		1				
	Cylinder lock - Zylinderschloss - Barillet de porte - Serratura - Cylinder slot - Ukse lukusüdamik		1	30x40			
		  <p>2290x1970</p>					

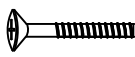
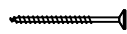
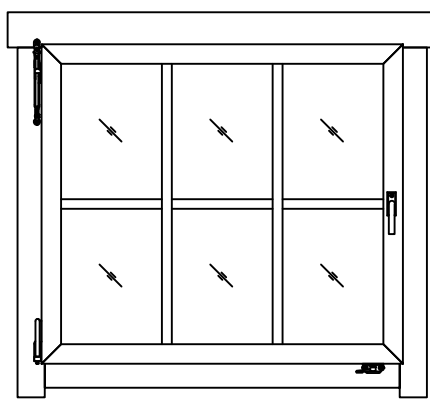
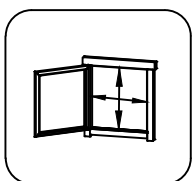
Pos	18.09.2017 Piece list - Stückliste - Liste des pièces - Elementi - Stuklijst - Joonis 990x882 AK.1.106.SSV.j SGC 9/9	Q	P (mm)	L (mm)
FS1	Window handle fittings - Fenstergriff - Poignee de fenetre - Maniglia c/ferramenta - Raamhendel -/grendel -/klink - Aknalink 	1		
FSP	Bolt for window handle fittings - Bolzen für fenstergriff beschlag - Vis pour fixation poignee de fenetre - Bullone x apertura manuale finestra - Schroef voor raamhendel - Akna käepideme polt 	2		
HS1	Screw for georgian bars - Schraube für sprossen - Vis pour croisillons - Viti per unire la griglia georgiana della finestra - Schroeven voor raamverdeling - Kruvi akna petteliistule 	6	2.5x20	
<p data-bbox="255 414 1284 459">Glass size - Glasgröße - Taille de la vitre - Misura del vetro - Glas afmeting - Klaasi mõõt: 846x738 mm</p>   <p data-bbox="1364 604 1492 649">890x782 mm</p>				